

TOMAHAWK

PILOT'S OPERATING HANDBOOK

DUPLICATE

AND

FAA APPROVED
AIRPLANE FLIGHT MANUAL

AIRPLANE SERIAL NO. 38-78A0488

AIRPLANE REGIST. NO. VH-TOM

8-112

PORT: 2126 FAA APPROVED BY:

Ward Evans

WARD EVANS
D.O.A. NO. SO-1
PIPER AIRCRAFT CORPORATION
VERO BEACH, FLORIDA

DATE OF APPROVAL:
JANUARY 20, 1978

FAA APPROVED IN NORMAL AND UTILITY CATEGORIES BASED ON FAR 23 AND FAR PART 21, SUBPART J. THIS HANDBOOK INCLUDES THE MATERIAL REQUIRED TO BE FURNISHED TO THE PILOT BY FAR 23 AND FAR PART 21, SUBPART J AND CONSTITUTES THE APPROVED AIRPLANE FLIGHT MANUAL AND MUST BE CARRIED IN THE AIRPLANE AT ALL TIMES.



WARNING

EXTREME CARE MUST BE EXERCISED TO LIMIT THE USE OF THIS HANDBOOK TO APPLICABLE AIRCRAFT. THIS HANDBOOK IS VALID FOR USE WITH THE AIRPLANE IDENTIFIED ON THE FACE OF THE TITLE PAGE. SUBSEQUENT REVISIONS SUPPLIED BY PIPER AIRCRAFT CORPORATION MUST BE PROPERLY INSERTED.

Published by
PUBLICATIONS DEPARTMENT
Piper Aircraft Corporation
Issued: January 20, 1978

Published by
PUBLICATIONS DEPARTMENT
Piper Aircraft Corporation
Issued: January 20, 1978

REPORT: 2126

ii

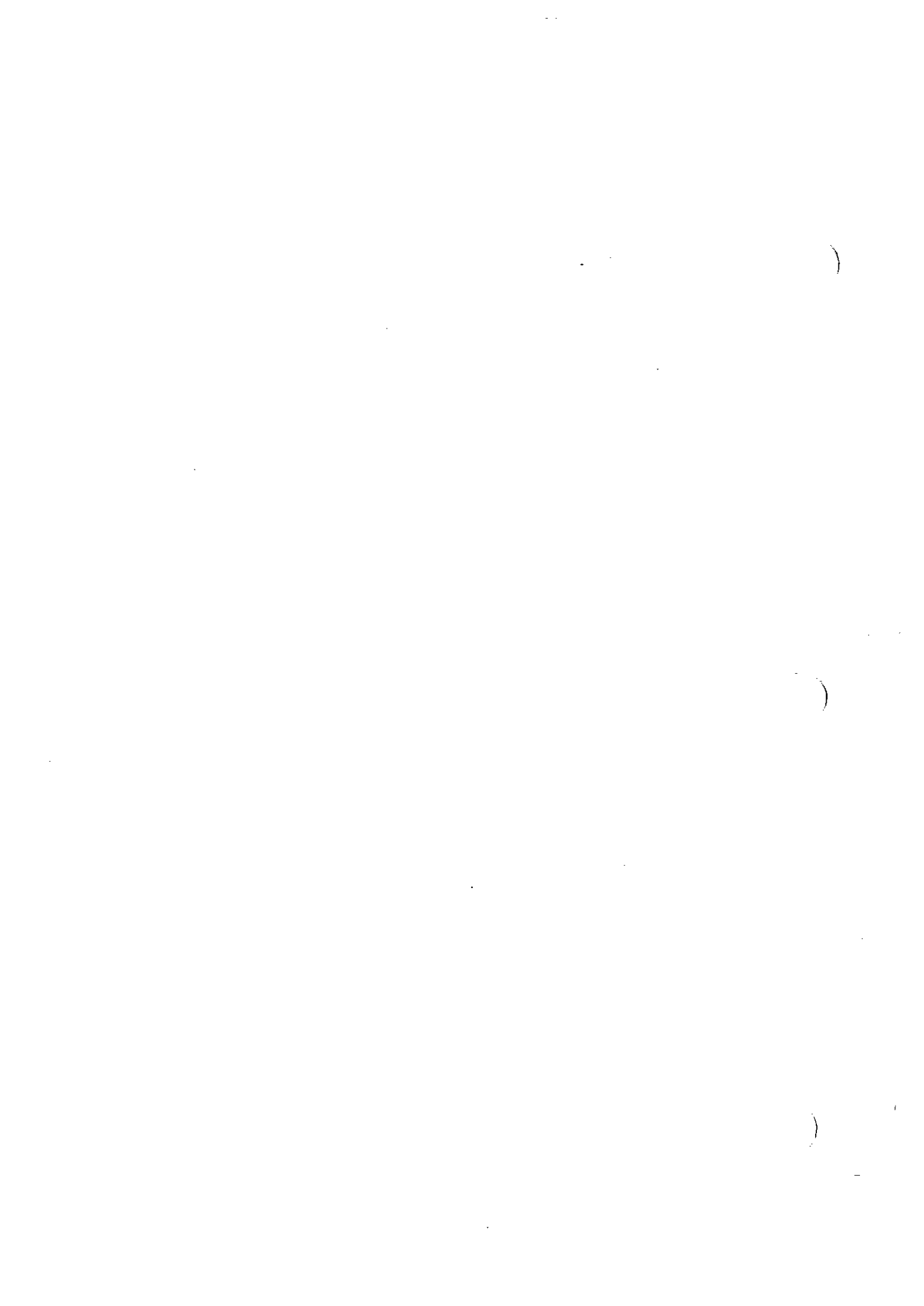

APPLICABILITY

Application of this handbook is limited to the specific Piper PA-38-112 model airplane designated by serial number and registration number on the face of the title page of this handbook.

This handbook cannot be used for operational purposes unless kept in a current status.

REVISIONS

The information compiled in the Pilot's Operating Handbook, with the exception of the equipment list, will be kept current by revisions distributed to the airplane owners. The equipment list was current at the time the airplane was licensed by the manufacturer and thereafter must be maintained by the owner.

Revision material will consist of information necessary to update the text of the present handbook and/or to add information to cover added airplane equipment.

I. Revisions

Revisions will be distributed whenever necessary as complete page replacements or additions and shall be inserted into the handbook in accordance with the instructions given below:

1. Revision pages will replace only pages with the same page number.
2. Insert all additional pages in proper numerical order within each section.
3. Page numbers followed by a small letter shall be inserted in direct sequence with the same common numbered page.

II. Identification of Revised Material

Revised text and illustrations shall be indicated by a black vertical line along the outside margin of the page, opposite revised, added or deleted material. A line along the outside margin of the page opposite the page number will indicate that an entire page was added.

Black lines will indicate only current revisions with changes and additions to or deletions of existing text and illustrations. Changes in capitalization, spelling, punctuation or the physical location of material on a page will not be identified.

ORIGINAL PAGES ISSUED

The original pages issued for this handbook prior to revision are given below:

Title, ii through vii, 1-1 through 1-21, 2-1 through 2-9, 3-1 through 3-14, 4-1 through 4-22, 5-1 through 5-29, 6-1 through 6-30, 7-1 through 7-23, 8-1 through 8-17, 9-1, and 10-1 through 10-2.

PILOT'S OPERATING HANDBOOK LOG OF REVISIONS

Current Revisions to the PA-38-112 Tomahawk Pilot's Operating Handbook, REPORT: 2126 issued January 20, 1978.

Revision Number and Code	Revised Pages	Description of Revision	FAA Approval Signature and Date
Rev. 1 761 658 (PR780623)	1-3	Revised 1.7 (c) (2) and (3).	
	1-4	Revised item 1.11 (c).	
	1-14	Revised ft.-lb. conversion.	
	1-16	Revised Kg conversion.	
	2-i	Added item 2.18.	
	2-5	Added item 2.18.	
	3-1	Corrected para. 3.1.	
	4-i	Revised page numbers.	
	4-6	Added new items; relocated items to pg. 4-7.	
	4-7	Added items from pg. 4-6; relocated item to pg. 4-8.	
	4-8	Added items from pg. 4-7; relocated items to pg. 4-9.	
	4-9	Added items from pg. 4-8; relocated items to pg. 4-10.	
	4-10	Added items from pg. 4-9; relocated items to pg. 4-11.	
	4-11	Added items from 4-10; relocated items to pg. 4-12.	
	4-12	Added items from pg. 4-11; relocated items to pg. 4-13.	
	4-13	Added items from pg. 4-13; relocated items to pg. 4-14.	
	4-14	Added items from pg. 4-14; relocated items to pg. 4-17.	
4-15	Added item 4.13 (d); relocated items to pg. 4-18.		
4-16	Relocated items to pgs. 4-18 and 4-19.		
4-17	Added new info.; added items from pg. 4-14; relocated items to pg. 4-20.		

REPORT: 2126

PILOT'S OPERATING HANDBOOK LOG OF REVISIONS (cont)

Revision Number and Code	Revised Pages	Description of Revision	FAA Approval Signature and Date
Rev. 1 (cont)	4-18	Added items from pg. 4-15; relocated items to pgs. 4-20 and 4-21.	
	4-19	Added items from pgs. 4-16 and 4-17; relocated items to pgs. 4-21 and 4-22.	
	4-20	Added items from pg. 4-17; relocated items to pgs. 4-22 and 4-23.	
	4-21	Added items from pg. 4-18; relocated items to pg. 4-24.	
	4-22	Added items from pgs. 4-19 and 4-20; relocated items to pgs. 4-24 and 4-25.	
	4-23	Added page; added items from pgs. 4-20 and 4-21.	
	4-24	Added page; added items from pg. 4-21.	
	4-25	Added page; added items from pg. 4-22.	
	5-12	Revised Figure 5-3.	
	6-9	Revised item 6.7.	
	6-10	Revised Figure 6-13.	
	6-14	Revised item 7.	
	6-20	Deleted item 101.	
	6-22	Revised items 125 and 127.	
	6-25	Revised items 171, 173 and 175.	
	6-26	Revised items 185, 187, 189, 191, 193, 195, 197, 199 and 201.	
	6-27	Revised items 203, 205, 207, 209, 211, 213, 215 and 217.	
	6-28	Revised items 219 and 223.	
	6-30	Added item 313.	
	7-16	Revised item 7.21.	
	8-11	Revised item 8.21 (b).	
	8-12	Removed chart.	<p align="right">Paul Everly June 23, 1978 <i>PE Everly</i></p>

PILOT'S OPERATING HANDBOOK LOG OF REVISIONS (cont)

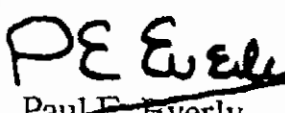
Revision Number and Code	Revised Pages	Description of Revision	FAA Approval Signature and Date
Rev. 2 761 658 (PR781013)	1-7, 1-18	Revised spelling.	 Paul E. Everly Oct. 13, 1978
	2-4	Added footnote.	
	3-6	Revised Spin Recovery info.	
	5-3	Revised Figure nos.	
	6-9, 6-10	Revised footnote.	
	6-13	Revised TC no.	
	6-19	Added item 90.	
	6-25	Revised item no.; added new items 172 and 173; revised items 171 and 175.	
	6-26	Revised item 185.	
	6-27	Deleted item 209; revised item nos.	
	6-28	Revised item nos.	
	6-29	Revised item 301.	
	7-2	Revised alternator volt.; added oil cooler info.; relocated info. to pg. 7-3.	
	7-3	Added info. from pg. 7-2.	
	7-12	Revised Figure 7-11.	
	7-18	Revised Figure 7-17.	
7-19	Added heat duct info.; relocated info. to pg. 7-21.		
7-21	Added info. from pg. 7-19.		
8-i, 8-17	Added para. 8.31, Winterization.		
Rev. 3 761 658 (PR781218)	2-2	Revised para. 2.5; relocated info. to pg. 2-3.	
	2-3	Added info. from pg. 2-2.	
	2-7	Added placard to para. 2.25.	
	2-9	Added placard to para. 2.25.	
	3-2	Added new stall speeds.	
	3-4, 3-9	Revised approach speed; added footnote.	
3-12	Revised para. 3.19.		

PILOT'S OPERATING HANDBOOK LOG OF REVISIONS (cont)

Revision Number and Code	Revised Pages	Description of Revision	FAA Approval Signature and Date
Rev. 3 761 658 (PR781218) (cont)	4-2	Revised para. 4.3 (e).	
	4-9	Revised approach speed.	
	4-20	Added info. from pg. 4-21.	
	4-21	Relocated info. to pg. 4-20;	
		revised approach speed;	
		added footnote.	
	4-24	Revised para. 4.43.	
	5-9	Added figures; revised pg.	
		nos.	
	5-10	Added Fig. 5-1 from pg. 5-11.	
	5-11	Relocated Fig. 5-1 to pg.	
		5-10; added relocated Fig.	
		from pg. 5-12.	
	5-12	Changed Fig. 5-3 to 5-2 and	
	relocated to pg. 5-11; added		
	new Fig. 5-3.		
5-28	Revised Fig. 5-35.		
5-28a	Added pg. (Added Fig. 5-36).		
5-28b	Added pg. (Added Fig. 5-37		
	from pg. 5-29).		
5-29	Relocated Fig. 5-37 to pg.		
	5-28b; added Fig. 5-38.		
6-18	Revised item 59.		
6-19	Added item 83.		
6-23	Revised item 135.		
6-30	Added item 315.		
Rev. 4 761 658 (PR790301)	1-3, 2-2	Revised to add optional	
		engine.	
	2-3	Revised item (1).	
	4-5	Revised engine cold start info.	
		Relocated material to pg. 4-6.	
4-6	Added relocated material.		
4-14	Revised para. 4.13 (a) (b) &		
	(c). Relocated material to pg.		
	4-15.		

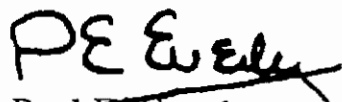
 Paul E. Everly
 Dec. 18, 1978

PILOT'S OPERATING HANDBOOK LOG OF REVISIONS (cont)

Revision Number and Code	Revised Pages	Description of Revision	FAA Approval Signature and Date
Rev. 4 761 658 (PR790301) (cont)	4-15	Revised and relocated material from pg. 4-14, para. 4.13 (c).	
	4-17	Added relocated & revised material from pg. 4-18.	
	4-18	Relocated material to pg. 4-17 Added note at top of pg.	
	6-1, 6-2	Revised para. 6.1.	
	6-9,	Added info. for seat position	
	6-10,	arm aft datum	
	6-11		
	6-14	Revised items 7 & 15.	
	6-15	Added item 27.	
	6-19	Added item 87 & relocated items 89 & 90 to pg. 6-20.	
	6-20	Added relocated items 89 & 90. Revised item 103.	
	6-21	Deleted items 109, 111, 113, 115, 117 & 119. Added new items 109 & 119. Added re-	
	6-22	located item 123 from pg. 6-22. Relocated item 123 to pg. 6-21. Added items 129 & 131.	
	7-2	Revised to add optional engine.	
7-8	Revised engine primer description.		
7-10	Added strobe light info. & warning. Relocated material to pg. 7-13.		
7-13	Added relocated material from Pg 7-10.		
8-11	Revised to add optional engine.		
Rev. 5 761 658 (PR790606)	1-4	Revised item 1.13.	 Paul E. Everly March 1, 1979
	2-3	Added winterization kit info. relocated info. to pg. 2-4.	

PILOT'S OPERATING HANDBOOK LOG OF REVISIONS (cont)

Revision Number and Code	Revised Pages	Description of Revision	FAA Approval Signature and Date
Rev. 5 761 658 (PR790606) (cont)	2-4	Added relocated info. from pg. 2-3.	
	2-6	Revised noise level value.	
	2-9	Added winterization placard info.	
	3-i	Revised index.	
	3-14	Added pitot-static pressure info.	
	4-6	Revised item.	
	4-7	Added item.	
	4-14	Revised item 4.13 (b).	
	4-18	Revised note.	
	5-1	Added 6.00 x 6 tire info. to item 5.3, relocated info. to pg. 5-2.	
	5-2	Added relocated items from pg. 5-1.	
	5-9	Revised list of Figures.	
	5-10	Relocated Fig. to pg. 5-10b.	
	5-10a	Added pg. (added new Fig. 5-1).	
	5-10b	Added pg. (added relocated Fig. from pg. 5-10).	
	6-9	Added values for sample problem.	
	6-21	Added item 104 and footnote; relocated items 121 and 123 to pg. 6-22.	
	6-22	Added relocated items from pg. 6-21.	
	6-25	Revised items 171, 172, 173, 174 and 175.	
	6-26	Revised items 201.	
6-27	Revised items 205 and 213.		
7-3	Added 6.00 x 6 tire info. to item 7.7.		

PILOT'S OPERATING HANDBOOK LOG OF REVISIONS (cont)

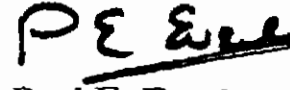
Revision Number and Code	Revised Pages	Description of Revision	FAA Approval Signature and Date
Rev. 5 761 658 (PR790606) (cont)	8-i	Revised index.	
	8-8	Added 6.00 x 6 tire info. to item 8.15, relocated items to pg. 8-10.	
	8-10	Added items from pg. 8-8; re-located items to 8-11.	
	8-11	Added items from pg. 8-10; relocated items to 8-12.	
	8-12	Added items from pg. 8-11.	
	8-13	Relocated items to pg. 8-14.	
	8-14	Added and revised items re-located items to pg. 8-15.	
	8-15	Added items from pg. 8-14; relocated items to pg. 8-16.	
	8-16	Added items from pg. 8-15; relocated items to pg. 8-17.	
	8-17	Added items from pg. 8-16; relocated items to pg. 8-18.	
8-18	Added pg; added and revised items from pg. 8-17.	 Paul E. Everly June 6, 1979	
Rev. 6 761 658 (PR791206)	2-5	Revised para. 2.18.	
	2-9	Added placard.	
	3-14	Revised para. 3.25.	
	4-7	Added to check list.	
	4-19	Revised para. 4.21.	
	5-13 thru	Revised Figs. 5-5 thru 5-15.	
	5-18		
5-20 thru	Revised Figs. 5-10 thru 5-35.		
5-28b	Revised figs. 5-37.	 Paul E. Everly Dec. 6, 1979	
7-12	Revised fig. 7-11.		

PILOT'S OPERATING HANDBOOK LOG OF REVISIONS (cont)

Revision Number and Code	Revised Pages	Description of Revision	FAA Approval Signature and Date
Rev. 7 761 658 (PR810115)	ii 1-2 1-4 2-i 2-5 2-6 2-7 2-8 2-9 2-10 4-4 4-12 4-13 4-17 6-i 6-14 6-16 6-17	Revised Warning. Revised fig. 1-1. Revised para. 1.13 (a) and (b). Revised Table of Contents. Relocated para. 2.18 to pg. 2-6. Relocated para. 2.23 to pg. 2-7; added para. 2.18 from pg. 2-5; revised para. 2.18 (a); added para. 2.18 (c). Relocated para. 2.25 to pg. 2-8; added para. 2.23 from pg. 2-6. Relocated placards to pg. 2-9; added placards from pg. 2-7. Relocated placards to pg. 2-10; added placards from pg. 2-8. Added pg.; added placards from pg. 2-9. Revised normal procedures checklist. Relocated info. to pg. 4-13; revised amplified normal procedures checklist; added new tire inflation specs. Added info. from pg. 4-12. Corrected spelling error. Revised Table of Contents. Revised item 7. Renumbered and relocated item to pg. 6-17; revised items 31 and 33. Relocated items to pg. 6-17a; added new items 35 and 37; added item from pg. 6-16.	

PILOT'S OPERATING HANDBOOK LOG OF REVISIONS (cont)

Revision Number and Code	Revised Pages	Description of Revision	FAA Approval Signature and Date
Rev. 7 761 658 (PR810115) (cont)	6-17a	Added pg.; added items from pg. 6-17; added new items 51 and 53.	
	6-17b	Added pg.; added items 57 thru 63 from pg. 6-18; revised item 59; added new item 62.	
	6-18	Relocated items 57 thru 63 to pg. 6-17b; added new item 69.	
	6-19	Revised item 87.	
	6-20	Revised item 103.	
	6-21	Revised item 104; deleted existing item 119; renumbered item.	
	6-22	Revised item 121; deleted item 129.	
	6-23	Revised items 135, 139 thru 145.	
	6-24	Revised items 149 and 153.	
	6-25	Relocated item 175 to pg. 6-26; deleted existing item 171; added new item 171; revised item 173.	
	6-26	Added item 175 from pg. 6-25; changed items 197 to 198 and relocated items 198 thru 201 to pg. 6-27.	
	6-27	Added new item 196 and 197; added items 198 thru 201 from pg. 6-26; relocated items 211 thru 213 to pg. 6-28.	
	6-28	Changed items 219 and 221 to 221 and 223 respectively; added items 211 thru 213 from pg. 6-27; added new item 219.	

PILOT'S OPERATING HANDBOOK LOG OF REVISIONS (cont)

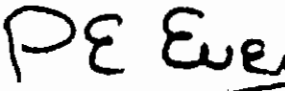
Revision Number and Code	Revised Pages	Description of Revision	FAA Approval Signature and Date
Rev. 7 761 658 (PR810115) (cont)	6-29	Revised items 301, 305 thru 311.	 Paul E. Everly Jan. 15, 1981
	6-30	Added new item 317 thru 321; relocated form to pg. 6-31.	
	6-31	Added pg.; added form from pg. 6-30.	
	7-i	Revised Table of Contents.	
	7-2	Added info. from pg. 7-3.	
	7-3	Relocated info. to pg. 7-2; added serial number effectivity to para. 7.7	
	7-11	Added serial number effectivity; revised schematic.	
	7-11a	Added pg.	
	7-11b	Added pg.; added fig. 7-9a.	
	7-13	Added serial number effectivity.	
	7-14	Revised fig. 7-13.	
	7-18	Revised fig. 7-17; added serial number effectivity.	
	7-19	Revised para. 7.25.	
	7-22	Corrected spelling error.	
	7-24	Added pg.; added para. 7.37.	
8-8	Added serial number effectivity to para. 8.15.		
8-14	Relocated info. to pg. 8-15; added serial number effectivity to para. 8.23.		
8-15	Added info. from pg. 8-14.		
Rev. 8 761 658 (PR810430)	2-10	Revised para. 2.25.	
	2-11	New page; cont. revision para. 2.25.	
	4-i	Changed pg. no.	
4-23	Revised para. 4.35; moved para. 4.39 to pg. 4-24.		

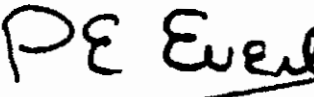

PILOT'S OPERATING HANDBOOK LOG OF REVISIONS (cont)

Revision Number and Code	Revised Pages	Description of Revision	FAA Approval Signature and Date
Rev. 8 761 658 (PR810430) (cont)	4-24	Relocated para. 4.39 from pg. 4.23; revised para. 4.4.	 Paul E. Everly April 30, 1981
	4-25	Cont. revision para. 4.43.	
	4-26,	New page; cont. revision	
	4-27	para. 4.43.	
	5-22	Revised fig. 5-23.	
	5-23	Revised fig. 5-25.	
	5-24	Revised fig. 5-27.	
	5-25	Revised fig. 5-29.	
	7-5	Relocated info. from pg. 7-6.	
	7-6	Moved info. to pg. 7-5; revised para. 7.13.	
	7- 17	Revised fig. 7-15.	
8-12	Revised para. 8.21.		
Rev. 9 761 658 (PR810630)	5-2	Added Warning.	
	6-i	Revised pg. no.	
	6-6	Revised Figure 6-7.	
	6-25	Renumbered items, revised and relocated item.	
	6-25a	Added pg. (added new items 177 thru 182).	
	6-25b	Added pg. (added revised, renumbered and relocated item 191; added new items 193 thru 197).	
	6-25c	Added pg.	
	6-25d	Added pg. (added revised, renumbered and relocated item 201; added new items 203 thru 207).	
	6-26	Relocated item; renumbered items; added relocated items.	
	6-27, 6-28	Relocated items; renumbered items; revised items	

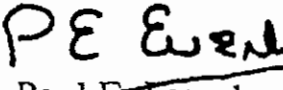
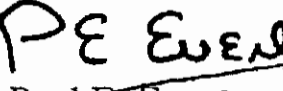
PILOT'S OPERATING HANDBOOK LOG OF REVISIONS (cont)

Revision Number and Code	Revised Pages	Description of Revision	FAA Approval Signature and Date
Rev. 9 761 658 (PR810630) (cont)	6-29	Added renumbered and re-located items; added new items 255 and 257.	 Paul E. Everly June 30, 1981
	6-30	Added relocated items.	
	6-31	Added relocated items; re-moved info.	
Rev. 10 761 658 (PR811102)	1-6	Corrected spelling error.	 Paul E. Everly Nov. 2, 1981
	2-3	Revised para. 2.7 (e); revised para. 2.9 (c).	
	2-6	Revised para. 2.18 (a).	
	4-7	Revised para. 4.5.	
	4-12	Revised para. 4.9.	
	4-18	Revised para. 4.19.	
	6-1	Revised para. 6.1.	
	6-6	Added paren. to fig. 6-7.	
	6-18	Revised item 65.	
	6-27	Revised item 235.	
Rev. 11 761 658 (PR820510)	iii	Revised revision para .	
	1-i	Revised Table of Contents.	
	1-12	Removed para. 1.21.	
	thru		
	1-21		
	2-1	Revised para. 2.1.	
	2-3	Revised para. 2.9.	
	3-i	Revised Table of Contents.	
	3-1	Revised para. 3.1.	
	4-i	Revised Table of Contents.	
	4-ii	New page; cont. revised Table of Contents.	
	4-1	Revised para. 4.1.	
	4-18	Revised Note.	

PILOT'S OPERATING HANDBOOK LOG OF REVISIONS (cont)

Revision Number and Code	Revised Pages	Description of Revision	FAA Approval Signature and Date
Rev. 11 761 658 (PR820510) (cont)	4-19	Revised para. 4.21.	<div style="text-align: center;">  Paul E. Everly May 10, 1982 </div>
	5-3	Revised para. 5.5(a), (b), (c), (d), (f), (g).	
	thru 5-7		
	6-i	Revised Table of Contents.	
	6-1	Revised para. 6.1.	
	6-2	Revised para. 6.3.	
	6-5	Revised para. 6.5.	
	6-6	Revised para. 6.7.	
	6-7	Revised para. 6.9.	
	6-13	Revised para. 6.9.	
	7-i	Revised Table of Contents.	
	7-8	Revised para. 7.13.	
	7-14	Revised fig. 7-13.	
	7-16	Revised para. 7.21.	
7-24	Added para. 7.39.		
Rev. 12 761 658 (PR821029)	1-12	Delete pg.	<div style="text-align: center;">  Paul E. Everly Oct. 29, 1982 </div>
	2-i	Revised Table of Contents	
	2-6	Relocated para. 2.21 to pg. 2-7; revised para. 2.18.	
	2-7	Added para 2.21 from pg. 2-6.	
	5-1	Revised para. 5.3.	
	8-2	Revised para. 8.3.	
	8-3	Revised para 8.3 info.; revised para. 8.5.	
8-4	Deleted para 8.5 info. from pg. 8-4.		
Rev. 13 761 658 (PR890428)	3-1	Revised para. 3.1.	
	4-8	Revised Short Field, Obstacle Clearance Takeoff.	
	7-3	Revised para. 7.7. Added Warning.	

PILOT'S OPERATING HANDBOOK LOG OF REVISIONS (cont)

Revision Number and Code	Revised Pages	Description of Revision	FAA Approval Signature and Date
Rev. 13 761 658 (PR890428) (cont)	7-5, 7-6 7-14 7-16 8-1 8-2 8-3	Revised para. 7.9. Revised fig. 7-13 callouts. Revised serial numbers. Revised para. 8.1 Revised paras. 8.1 and 8.3. Revised para. 8.3.	 D. H. Trompler May 15, 1989 <hr/> Date

TABLE OF CONTENTS

SECTION 1	GENERAL
SECTION 2	LIMITATIONS
SECTION 3	EMERGENCY PROCEDURES
SECTION 4	NORMAL PROCEDURES
SECTION 5	PERFORMANCE
SECTION 6	WEIGHT AND BALANCE
SECTION 7	DESCRIPTION AND OPERATION OF THE AIRPLANE AND ITS SYSTEMS
SECTION 8	AIRPLANE HANDLING, SERVICING AND MAINTENANCE
SECTION 9	SUPPLEMENTS
SECTION 10	OPERATING TIPS

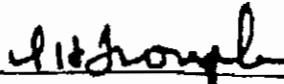
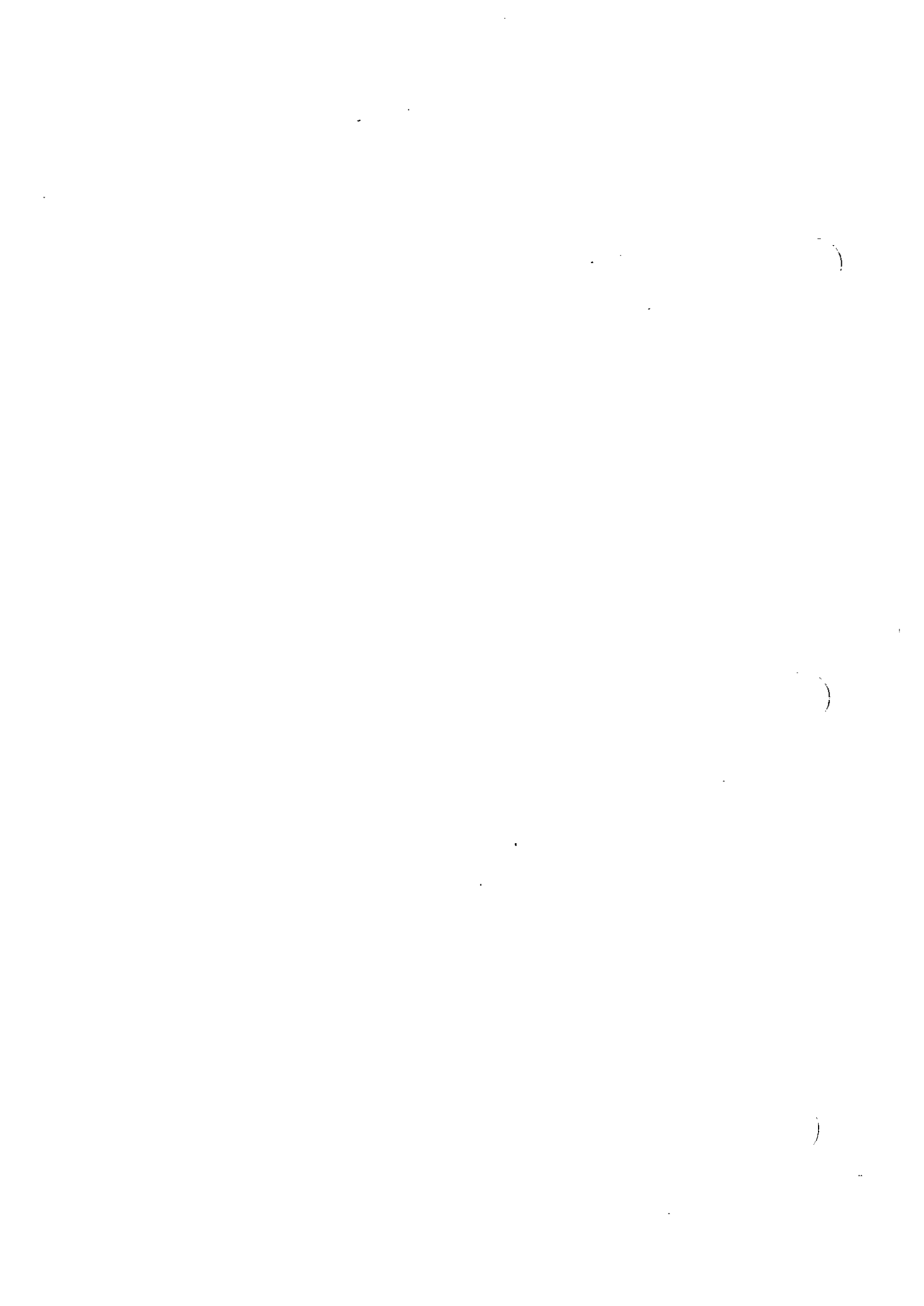

TABLE OF CONTENTS

SECTION 1

GENERAL

Paragraph No.		Page No.
1.1	Introduction	1-1
1.3	Engine.....	1-3
1.5	Propeller	1-3
1.7	Fuel.....	1-3
1.9	Oil	1-4
1.11	Maximum Weights	1-4
1.13	Standard Airplane Weights.....	1-4
1.15	Baggage Space	1-4
1.17	Specific Loadings	1-5
1.19	Symbols, Abbreviations and Terminology	1-6

BLANK PAGE

SECTION 1

GENERAL

1.1 INTRODUCTION

This Pilot's Operating Handbook is designed for maximum utilization as an operating guide for the pilot. It includes the material required to be furnished to the pilot by FAR 23 and FAR Part 21, Subpart J. It also contains supplemental data supplied by the airplane manufacturer.

This handbook is not designed as a substitute for adequate and competent flight instruction, knowledge of current airworthiness directives, applicable federal air regulations or advisory circulars. It is not intended to be a guide for basic flight instruction or a training manual and should not be used for operational purposes unless kept in a current status.

Assurance that the airplane is in an airworthy condition is the responsibility of the owner. The pilot in command is responsible for determining that the airplane is safe for flight. The pilot is also responsible for remaining within the operating limitations as outlined by instrument markings, placards, and this handbook.

Although the arrangement of this handbook is intended to increase its in-flight capabilities, it should not be used solely as an occasional operating reference. The pilot should study the entire handbook to become familiar with the limitations, performance, procedures and operational handling characteristics of the airplane before flight.

The handbook has been divided into numbered (arabic) sections, each provided with a "finger-tip" tab divider for quick reference. The limitations and emergency procedures have been placed ahead of the normal procedures, performance and other sections to provide easier access to information that may be required in flight. The "Emergency Procedures" Section has been furnished with a red tab divider to present an instant reference to the section. Provisions for expansion of the handbook have been made by the deliberate omission of certain paragraph numbers, figure numbers, item numbers and pages noted as being left blank intentionally.

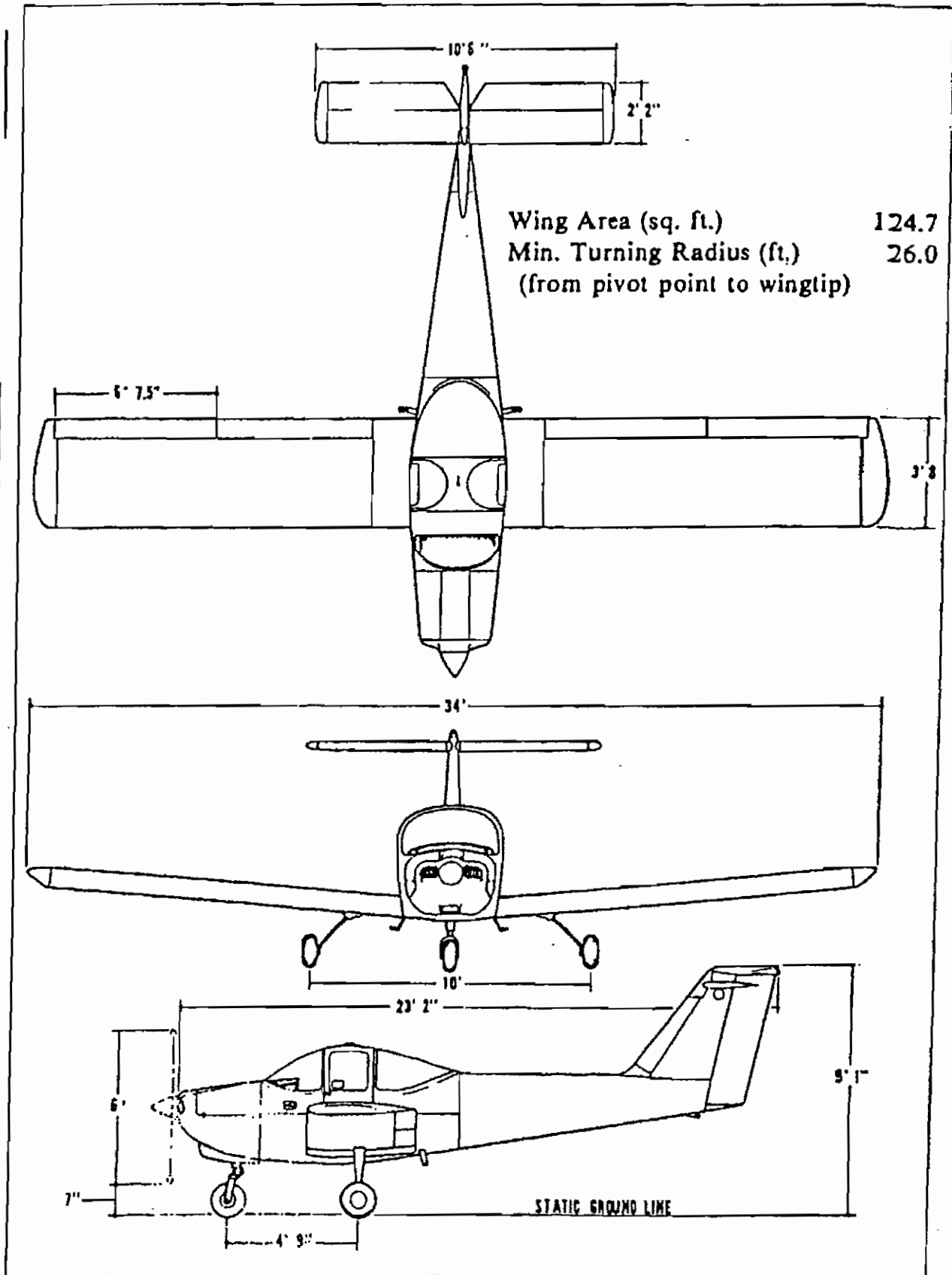

THREE VIEW
Figure 1-1

1.3 ENGINE

(a) Number of Engines	1
(b) Engine Manufacturer	Lycoming
(c) Engine Model Number	O-235-L2C (with Slick Mags.) or O-235-L2A (with Bendix Mags.)
(d) Rated Horsepower	112
(e) Rated Speed (rpm)	2600
(f) Bore (in.)	4.375
(g) Stroke (in.)	3.875
(h) Displacement (cu. in.)	233.3
(i) Compression Ratio	8.5:1
(j) Engine Type	Four Cylinder, Direct Drive, Horizontally Opposed, Air Cooled

1.5 PROPELLER

(a) Number of Propellers	1
(b) Propeller Manufacturer	Sensenich
(c) Model	72CK-0-56
(d) Number of Blades	2
(e) Propeller Diameter (in.)	
(1) Maximum	72
(2) Minimum	70
(f) Propeller Type	Fixed Pitch

1.7 FUEL

(a) Fuel Capacity (U.S. gal.) (total)	32
(b) Usable Fuel (U.S. gal.) (total)	30
(c) Fuel Grade, Aviation	
(1) Minimum Octane	100/130-Green
(2) Specified Octane	100/130-Green 100-Green 100LL-Blue
(3) Alternate Fuels*	115/145-Purple

* Alternate Fuels refers to military grade with 4.6 ml of TEL. See Section 8.25, Fuel System.

1.9 OIL

- (a) Oil Capacity (U.S. qts.) 6
- (b) Oil specification Refer to latest issue
of Lycoming Service
Instruction 1014.
- (c) Oil Viscosity Refer to Section 8 -
paragraph 8.19.

1.11 MAXIMUM WEIGHTS

	Normal	Utility
(a) Maximum Takeoff Weight (lbs.)	1670	1670
(b) Maximum Landing Weight (lbs.)	1670	1670
(c) Maximum Weight (lbs.) in Baggage Compartment at Fuselage Station 115.0	100	100

1.13 STANDARD AIRPLANE WEIGHTS*

- (a) Standard Empty Weight (lbs.):
Weight of a standard airplane includ-
ing unusable fuel, full operating
fluids and full oil. 1128
- (b) Maximum Useful Load (lbs.): The
difference between the Maximum
Takeoff Weight and the Standard
Empty Weight. 542

1.15 BAGGAGE SPACE

- (a) Compartment Volume (cu. ft.) 20
- (b) Floor Loading (lbs. per sq. ft.) 25

*These values are approximate and vary from one aircraft to another. Refer to Figure 6-7 for the Standard Empty Weight value and the Useful Load value to be used for C.G. calculations for the aircraft specified.

1.17 SPECIFIC LOADINGS

(a) Wing Loading (lbs. per sq. ft.)	13.39
(b) Power loading (lbs. per hp)	14.9

1.19 SYMBOLS, ABBREVIATIONS AND TERMINOLOGY

The following definitions are of symbols, abbreviations and terminology used throughout the handbook and those which may be of added operational significance to the pilot.

(a) General Airspeed Terminology and Symbols

CAS	Calibrated Airspeed means the indicated speed of an aircraft, corrected for position and instrument error. Calibrated airspeed is equal to true airspeed in standard atmosphere at sea level.
KCAS	Calibrated Airspeed expressed in "Knots."
GS	Ground Speed is the speed of an airplane relative to the ground.
IAS	Indicated Airspeed is the speed of an aircraft as shown on the airspeed indicator when corrected for instrument error. IAS values published in this handbook assume zero instrument error.
KIAS	Indicated Airspeed expressed in "Knots."
M	Mach number is the ratio of true airspeed to the speed of sound.
TAS	True Airspeed is the airspeed of an airplane relative to undisturbed air which is the CAS corrected for altitude, temperature and compressibility.
V_A	Maneuvering Speed is the maximum speed at which application of full available aerodynamic control will not overstress the airplane.
V_{FE}	Maximum Flap Extended Speed is the highest speed permissible with wing flaps in a prescribed extended position.

V_{NE}/M_{NE}	Never Exceed Speed or Mach Number is the speed limit that may not be exceeded at any time.
V_{NO}	Maximum Structural Cruising Speed is the speed that should not be exceeded except in smooth air and then only with caution.
V_S	Stalling Speed or the minimum steady flight speed at which the airplane is controllable.
V_{SO}	Stalling Speed or the minimum steady flight speed at which the airplane is controllable in the landing configuration.
V_X	Best Angle-of-Climb Speed is the airspeed which delivers the greatest gain of altitude in the shortest possible horizontal distance.
V_Y	Best Rate-of-Climb Speed is the airspeed which delivers the greatest gain in altitude in the shortest possible time.

(b) Meteorological Terminology

ISA	International Standard Atmosphere in which: The air is a dry perfect gas; The temperature at sea level is 15° Celsius (59° Fahrenheit); The pressure at sea level is 29.92 inches Hg (1013 mb); The temperature gradient from sea level to the altitude at which the temperature is -56.5° C (-69.7°F) is -0.00198°C (-0.003566°F) per foot and zero above that altitude.
OAT	Outside Air Temperature is the free air static temperature obtained either from inflight temperature indications or ground meteorological sources, adjusted for instrument error and compressibility effects.

Indicated Pressure Altitude The number actually read from an altimeter when the barometric subscale has been set to 29.92 inches of mercury (1013 millibars).

Pressure Altitude Altitude measured from standard sea-level pressure (29.92 in. Hg) by a pressure or barometric altimeter. It is the indicated pressure altitude corrected for position and instrument error. In this handbook, altimeter instrument errors are assumed to be zero.

Station Pressure Actual atmospheric pressure at field elevation.

Wind The wind velocities recorded as variables on the charts of this handbook are to be understood as the headwind or tailwind components of the reported winds.

(c) Power Terminology

Takeoff Power Maximum power permissible for takeoff.

Maximum Continuous Power Maximum power permissible continuously during flight.

Maximum Climb Power Maximum power permissible during climb.

Maximum Cruise Power Maximum power permissible during cruise.

(d) Engine Instruments

EGT Gauge Exhaust Gas Temperature Gauge

Maximum
Takeoff Weight

Maximum weight approved for the start of
the takeoff run.

Maximum
Landing Weight

Maximum weight approved for the landing
touchdown.

Maximum Zero
Fuel Weight

Maximum weight exclusive of usable fuel.

BLANK PAGE

TABLE OF CONTENTS

SECTION 2

LIMITATIONS

Paragraph No.		Page No.
2.1	General.....	2-1
2.3	Airspeed Limitations	2-1
2.5	Airspeed Indicator Markings	2-2
2.7	Power Plant Limitations	2-2
2.9	Power Plant Instrument Markings	2-3
2.11	Weight Limits	2-4
2.13	Center of Gravity Limits.....	2-4
2.15	Maneuver Limits.....	2-5
2.17	Flight Maneuvering Load Factors	2-5
2.18	Service Life Limits	2-6
2.19	Types of Operations	2-6
2.21	Fuel Limitations.....	2-7
2.23	Noise Levels	2-7
2.25	Placards.....	2-8

BLANK PAGE

SECTION 2
LIMITATIONS

2.1 GENERAL

This section provides the "FAA Approved" operating limitations, instrument markings, color coding and basic placards necessary for the operation of the airplane and its systems.

This airplane must be operated as a normal or utility category airplane in compliance with the operating limitations stated in the form of placards and markings and those given in this section and handbook.

Limitations associated with those optional systems and equipment which require handbook supplements can be found in Section 9 (Supplements).

2.3 AIRSPEED LIMITATIONS

SPEED	KIAS	KCAS
Design Maneuvering Speed (VA)- Do not make full or abrupt control movements above this speed.		
1670 lbs.	103	101
1277 lbs.	90	88

CAUTION

Maneuvering speed decreases at lighter weight as the effects of aerodynamic forces become more pronounced. Linear interpolation may be used for intermediate gross weights. Maneuvering speed should not be exceeded while operating in rough air.

**SECTION 2
LIMITATIONS**

**PIPER AIRCRAFT CORPORATION
PA-38-112, TOMAHAWK**

SPEED	KIAS	KCAS
Never Exceed Speed (VNE) - Do not exceed this speed in any operation.	138	143
Maximum Structural Cruising Speed (VNO) - Do not exceed this speed except in smooth air and then only with caution.	110	108
Maximum Flaps Extended Speed (VFE) - Do not exceed this speed with the flaps extended.	89	87

2.5 AIRSPEED INDICATOR MARKINGS

MARKING	IAS
Red Radial Line (Never Exceed)	138 KTS
Yellow Arc (Caution Range - Smooth Air Only)	110 KTS to 138 KTS
Green Arc (Normal Operating Range) (Outboard Flow Strips Installed)	48 KTS to 110 KTS
Green Arc (Normal Operating Range) (Outboard and Inboard Flow Strips Installed)	52 KTS to 110 KTS
White Arc (Flap Down) (Outboard Flow Strips Installed)	47 KTS to 89 KTS
White Arc (Flap Down) (Outboard and Inboard Flow Strips Installed)	49 KTS to 89 KTS

2.7 POWER PLANT LIMITATIONS

(a) Number of Engines	1
(b) Engine Manufacturer	Lycoming
(c) Engine Model No.	O-235-L2C (with Slick Mags.) or O-235-L2A (with Bendix Mags.)

In view of the pilot (Aircraft with serial numbers 38-78A0001 thru 38-81A0006):

ALTERNATE STATIC
SOURCE
TO OPEN PUSH
FORWARD

In view of the pilot (Aircraft with serial numbers 38-81A0007 and up):

ALTERNATE STATIC
SOURCE
STATIC
SYSTEM DRAIN
TO OPEN RAISE
HANDLE

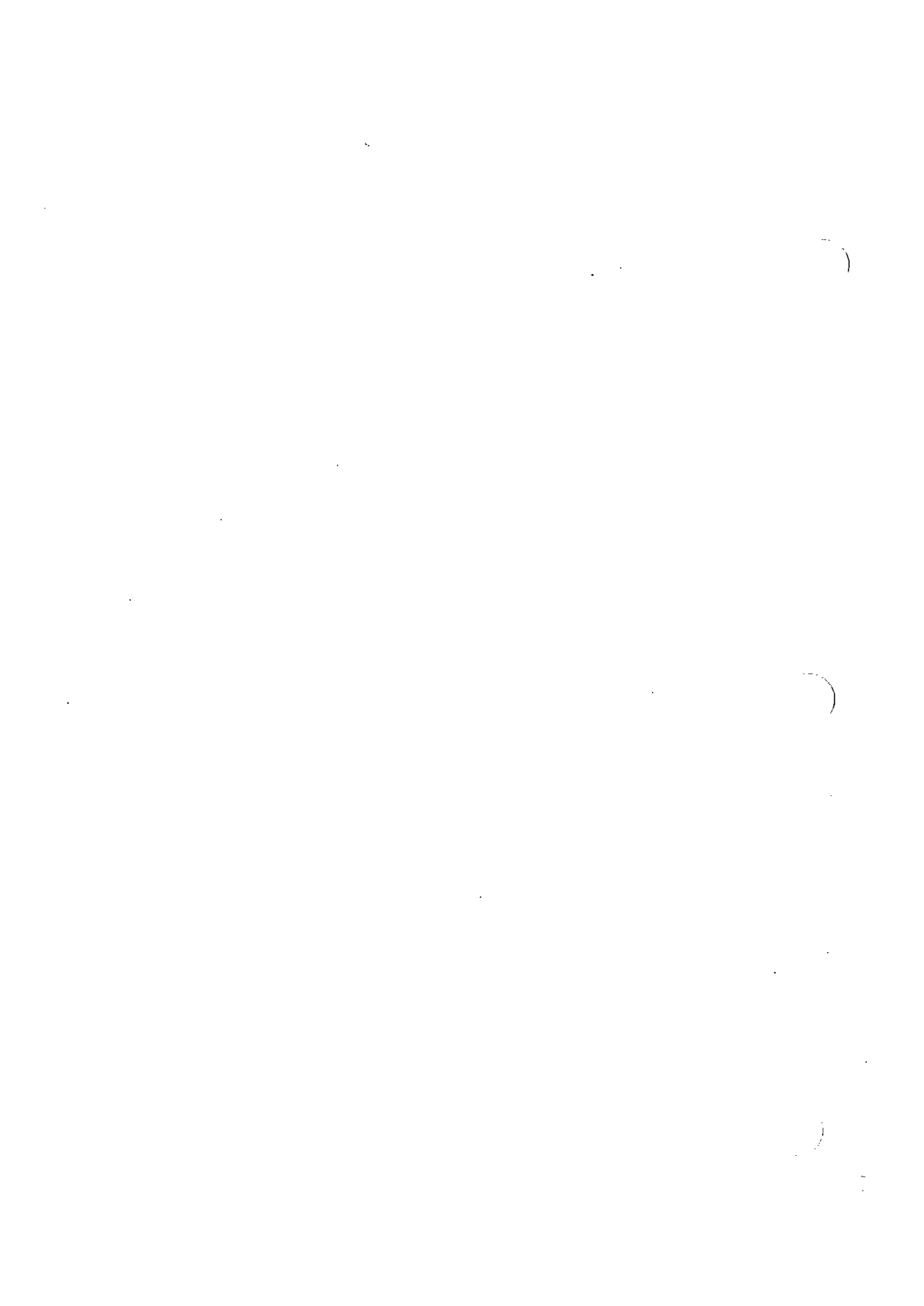

In full view of the pilot:

TAKEOFF CHECK LIST

Fuel - Proper Tank	Belts/harness - Fastened
Mixture - Set	Flaps - Set
Electric Fuel Pump - On	Trim - Set
Carburetor Heat - Off	Controls - Free
Engine Gages - Checked	Doors - Latched
Seats & Backs - Latched	

LANDING CHECK LIST

Fuel - Proper Tank	Seats & Backs - Latched
Mixture - Rich	Flaps - Set (White Arc)
Electric Fuel Pump - On	Belts/Harness - Fastened

On baggage compartment aft bulkhead:

BAGGAGE
MAX. 100 LBS

SEE PILOTS OPERATING HANDBOOK
FOR LOAD DISTRIBUTION

In full view of the pilot, near the airspeed indicator:

MANEUVERING SPEED 103 KIAS
AT 1670 LBS (SEE P.O.H.)

In full view of the pilot, on the throttle quadrant:

FUEL REMAINING WHEN THE QUANTITY
INDICATORS READ ZERO CANNOT BE USED
SAFELY IN FLIGHT

15 U. S. GAL.
USABLE

FUEL

15 U. S. GAL.
USABLE

L
TANK

R
TANK

In full view of the pilot, on the throttle quadrant:

FUEL
OFF

In full view of the pilot, near the carburetor heat control:

OFF

CARB.
HEAT

ON

On optional document container:

THIS CONTAINER PROVIDED FOR
AIRCRAFT DOCUMENTS MAXIMUM
WEIGHT OF CONTENTS 1.5 LBS.

In full view of the pilot:

WINTERIZATION PLATES (4)
REMOVE WHEN AMBIENT
TEMPERATURE EXCEEDS 50°F

On lower side panel, adjacent to pilot seat (Aircraft with serial numbers
38-78A0001 thru 38-81A0006):

STATIC
SYSTEM DRAIN

2.21 FUEL LIMITATIONS

- | | |
|--|--------------|
| (a) Total Capacity | 32 U.S. GAL. |
| (b) Unusable fuel | 2 U.S. GAL. |
| The unusable fuel for this airplane has been determined as 1.0 gallon in each wing in critical flight attitudes. | |
| (c) Usable Fuel | 30 U.S. GAL. |
| The usable fuel in this airplane has been determined as 15.0 gallons in each wing. | |
| (d) Fuel remaining when a quantity indicator reads zero cannot be used safely in flight. | |

2.23 NOISE LEVEL

The noise level of this aircraft is 67.8d B(A).

No determination has been made by the Federal Aviation Administration that the noise levels of this airplane are or should be acceptable or unacceptable for operation at, into, or out of any airport.

The above statement notwithstanding, the noise level stated above has been verified by and approved by the Federal Aviation Administration in noise level test flights conducted in accordance with FAR 36, Noise Standards - Aircraft Type and Airworthiness Certification. This aircraft model is in compliance with all FAR 36 noise standards applicable to this type.

2.25 PLACARDS

In full view of the pilot:

Except as may be otherwise indicated on a placard, the markings and placards installed in this airplane contain operating limitations which must be complied with when operating this airplane in the normal category. Other operating limitations which must be complied with when operating this airplane in this category or in the utility category are contained in the Pilots Operating Handbook.

Flaps up spins are approved for utility category operation. For spin recovery, use full rudder against the spin followed immediately by forward wheel.

This airplane is approved for flight in day/night VFR/IFR when equipped in accordance with F.A.R. 91. Flight into known icing conditions is prohibited.

DEMONSTRATED CROSSWIND COMPONENT 15 KNOTS

FLAPS EXTENDED SPINS PROHIBITED

UTILITY CATEGORY OPERATION ONLY
MANEUVERS ARE LIMITED TO THE FOLLOWING

	ENTRY SPEED
SPINS (FLAPS UP)	STALL
STEEP TURNS	100 KIAS
LAZY EIGHTS	100 KIAS
CHANDELLES	100 KIAS

WARNING

TURN OFF STROBE LIGHTS WHEN IN
CLOSE PROXIMITY TO GROUND OR
DURING FLIGHT THROUGH CLOUD,
FOG OR HAZE.

NOTES

Straight line variation between points given.

The datum used is 66.25 inches ahead of the wing leading edge.

It is the responsibility of the airplane owner and the pilot to insure that the airplane is properly loaded. See Section 6 (Weight and Balance) for proper loading instructions.

2.15 MANEUVER LIMITS

- (a) Normal Category - All acrobatic maneuvers including spins prohibited.
- (b) Utility Category - Approved maneuvers for Utility Category Only.

MANEUVER	ENTRY SPEED
Spins (flaps up)	Stall
Steep Turns	100 KIAS
Lazy Eights	100 KIAS
Chandelles	100 KIAS

2.17 FLIGHT MANEUVERING LOAD FACTORS

	Normal	Utility
(a) Positive Load Factor (Maximum)		
(1) Flaps Up	3.8 G	4.4 G
(2) Flaps Down	2.0 G	2.0 G
(b) Negative Load Factor (Maximum)	No inverted maneuvers approved.	

2.18 SERVICE LIFE LIMITS

- (a) The lower longitudinal trim springs, drawing number 37523 or 61916-2, have a life limit of 1500 hours.
- (b) The service life of the wing, drawing number 77352, and associated structure has been established as 11,000 hours maximum.
- (c) The service life of the Steel Upper Rudder Hinge, drawing number 77610-03, has been established as 5000 hours of operation.
- (d) On aircraft with serial numbers 38-78A0001 through 38-80A0198, the service life of the fin spar attachment plate, drawing number 77553-05, has been established as 3000 hours of operation.
- (e) On aircraft with serial numbers 38-81A0001 through 38-82A0101 without Piper Kit 764 421 installed, the service life of the fin spar attachment plate, drawing number 77553-05, has been established as 3000 hours of operation.
- (f) On aircraft with serial numbers 38-81A0001 through 38-82A0101 with Piper Kit 764 421 installed, the service life of the fin spar attachment plate, drawing number 77553-05, has been established as 5000 hours of operation.
- (g) On aircraft with serial numbers 38-82A0102 and up, the service life of the fin spar attachment plate, drawing number 77553-05, has been established as 5000 hours of operation.

2.19 TYPES OF OPERATION

The airplane is approved for the following operations when equipped in accordance with FAR 91.

- (a) Day V.F.R.
- (b) Night V.F.R.
- (c) Day I.F.R.
- (d) Night I.F.R.
- (e) Non Icing

(d) Engine Operating Limits	
(1) Maximum Horsepower	112
(2) Maximum Rotation Speed (RPM)	2600
(3) Maximum Oil Temperature	245°F
(e) Oil Pressure	
Minimum (red line)	*15 PSI
Maximum (red line)	100 PSI
(f) Fuel Pressure	
Minimum (red line)	.5 PSI
Maximum (red line)	8 PSI
(g) Fuel Grade - Minimum	100/130 - Green
(h) Number of Propellers	1
(i) Propeller Manufacturer	Sensenich
(j) Propeller Model	72CK-0-56
(k) Propeller Diameter	
Maximum	72 IN.
Minimum	70 IN.
(l) Propeller Tolerance (static RPM at maximum permissible throttle setting)	
Not above	2350 RPM
Not below	2200 RPM
No additional tolerance permitted.	
(m) Winterization Kit (Optional)	
(1) Removed above 50° F OAT	
(2) OAT gauge required	

2.9 POWER PLANT INSTRUMENT MARKINGS

(a) Tachometer	
Green Arc (Normal Operating Range)	500 to 2600 RPM
Red Line (Maximum Continuous Power)	2600 RPM
(b) Oil Temperature	
Green Arc (Normal Operating Range)	75° to 245°F
Red Line (Maximum)	245°F
(c) Oil Pressure	
Green Arc (Normal Operating Range)	60 PSI to 90 PSI
Yellow Arc (Caution Range) (Idle)	*15 PSI to 60 PSI
Yellow Arc (Ground Warm-Up)	90 PSI to 100 PSI
Red Line (Minimum)	*15 PSI
Red Line (Maximum)	100 PSI

*Minimum limit reduced from 25 psi. All models approved for 15 psi.

**SECTION 2
LIMITATIONS**

**PIPER AIRCRAFT CORPORATION
PA-38-112, TOMAHAWK**

(d) Fuel Pressure	
Green Arc (Normal Operating Range)	.5 PSI to 8 PSI
Red Line (Minimum)	.5 PSI
Red Line (Maximum)	8 PSI

2.11 WEIGHT LIMITS

	Normal	Utility
(a) Maximum Weight	1670 lbs.	1670 lbs.
(b) Maximum Baggage at Fuselage Station 115.0	100 lbs.	100 lbs.*

CAUTION

Baggage compartment loading should not exceed 25 lbs. per square foot.

2.13 CENTER OF GRAVITY LIMITS

(a) Normal Category

Weight Pounds	Forward Limit Inches Aft of Datum	Rearward Limit Inches Aft of Datum
1670	73.5	78.5
1277	72.4	78.5

(b) Utility Category

Weight Pounds	Forward limit Inches Aft of Datum	Rearward Limit Inches Aft of Datum
1670	73.5	78.5
1277	72.4	78.5

*No baggage allowed for spins.

(e) Airplane Performance and Flight Planning Terminology

Climb Gradient	The demonstrated ratio of the change in height during a portion of a climb, to the horizontal distance traversed in the same time interval.
Demonstrated Crosswind Velocity	The demonstrated crosswind velocity is the velocity of the crosswind component for which adequate control of the airplane during takeoff and landing was actually demonstrated during certification tests.
Accelerate-Stop Distance	The distance required to accelerate an airplane to a specified speed and, assuming failure of an engine at the instant that speed is attained, to bring the airplane to a stop.
MEA	Minimum en route IFR altitude.
Route Segment	A part of a route. Each end of that part is identified by: (1) a geographical location; or (2) a point at which a definite radio fix can be established.

(f) Weight and Balance Terminology

Reference Datum	An imaginary vertical plane from which all horizontal distances are measured for balance purposes.
Station	A location along the airplane fuselage usually given in terms of distance in inches from the reference datum.
Arm	The horizontal distance from the reference datum to the center of gravity (C.G.) of an item.
Moment	The product of the weight of an item multiplied by its arm. (Moment divided by a constant is used to simplify balance calculations by reducing the number of digits.)

**SECTION 1
GENERAL**

**PIPER AIRCRAFT CORPORATION
PA-38-112, TOMAHAWK**

Center of Gravity (C.G.)	The point at which an airplane would balance if suspended. Its distance from the reference datum is found by dividing the total moment by the total weight of the airplane.
C.G. Arm	The arm obtained by adding the airplane's individual moments and dividing the sum by the total weight.
C.G. Limits	The extreme center of gravity locations within which the airplane must be operated at a given weight.
Usable Fuel	Fuel available for flight planning.
Unusable Fuel	Fuel remaining after a runout test has been completed in accordance with governmental regulations.
Standard Empty Weight	Weight of a standard airplane including unusable fuel, full operating fluids and full oil.
Basic Empty Weight	Standard empty weight plus optional equipment.
Payload	Weight of occupants, cargo and baggage.
Useful Load	Difference between takeoff weight, or ramp weight if applicable, and basic empty weight.
Maximum Ramp Weight	Maximum weight approved for ground maneuver. (It includes weight of start, taxi and run up fuel.)

TABLE OF CONTENTS

SECTION 3

EMERGENCY PROCEDURES

Paragraph No.		Page No.
3.1	General.....	3-1
3.3	Emergency Procedures Checklist	3-2
	Speeds	3-2
	Engine Inoperative Procedures	3-2
	Fire	3-4
	Loss of Oil Pressure	3-5
	Loss of Fuel Pressure	3-5
	High Oil Temperature	3-5
	Alternator Failure.....	3-5
	Spin Recovery	3-5
	Open Door.....	3-6
	Engine Roughness.....	3-6
3.5	Amplified Emergency Procedures (General).....	3-7
3.7	Engine Inoperative Procedures.....	3-7
	Engine Power Loss During Takeoff (Not Airborne).....	3-7
	Engine Power Loss During Takeoff (If Airborne).....	3-7
	Engine Power Loss In Flight.....	3-8
	Power off Landing	3-9
3.9	Fire.....	3-9
	Engine Fire During Start.....	3-9
	Fire In Flight	3-10
3.11	Loss of Oil Pressure.....	3-11
3.13	Loss Of Fuel Pressure	3-11
3.15	High Oil Temperature	3-11
3.17	Alternator Failure.....	3-12
3.19	Spin Recovery (Unintentional Spin).....	3-12
3.21	Open Door	3-13
3.23	Engine Roughness	3-13
3.25	Loss of Pitot-Static Pressure.....	3-14



SECTION 3

EMERGENCY PROCEDURES

3.1 GENERAL

The recommended procedures for coping with various types of emergencies and critical situations are provided by this section. All of required (FAA regulations) emergency procedures and those necessary for operation of the airplane as determined by the operating and design features of the airplane are presented.

Emergency procedures associated with those optional systems and equipment which require handbook supplements are provided in Section 9 (Supplements).

The first portion of this section consists of an abbreviated emergency checklist which supplies an action sequence for critical situations with little emphasis on the operation of systems.

The remainder of the section is devoted to amplified emergency procedures containing additional information to provide the pilot with a more complete understanding of the procedures.

These procedures are suggested as a course of action for coping with the particular condition described, but are not a substitute for sound judgment and common sense. Pilots should familiarize themselves with the procedures given in this section and be prepared to take appropriate action should an emergency arise.

Most basic emergency procedures, such as power off landings, are a normal part of pilot training. Although these emergencies are discussed here, this information is not intended to replace such training, but only to provide a source of reference and review, and to provide information on procedures which are not the same for all aircraft. It is suggested that the pilot review standard emergency procedures periodically to remain proficient in them.

3.3 EMERGENCY PROCEDURES CHECKLIST

SPEEDS

Stall speeds

1670 lbs (0° flap) (Outboard Flow Strips Installed).....48 KIAS

1670 lbs. (full flap) (Outboard Flow Strips Installed).....47 KIAS

1670 lbs. (0° flap) (Outboard and Inboard Flow Strips Installed)52 KIAS

1670 lbs. (full flap) (Outboard and Inboard Flow Strips Installed)49 KIAS

Maneuvering speeds

1670 lbs.....103 KIAS

1277 lbs.....90 KIAS

Never exceed speed.....138 KIAS

Power off glide speeds

1670 lbs. (0° flap).....70 KIAS

ENGINE INOPERATIVE PROCEDURES

ENGINE POWER LOSS DURING TAKEOFF (NOT AIRBORNE)

Sufficient runway remaining:

Throttleclose immediately

Brakesapply as required

Stop straight ahead.

Insufficient runway remaining:

Throttleclose immediately

Brakesapply as required

MixtureIDLE CUT-OFF

Fuel selectorOFF

Master switchOFF

MagnetosOFF

Maintain directional control and maneuver to avoid obstacles.

ENGINE POWER LOSS DURING TAKEOFF (IF AIRBORNE)

Sufficient runway remaining:

Airspeedmaintain above stall

Directional controlmaintain

Land straight ahead.

Insufficient runway remaining:

Airspeedmaintain above stall
Throttleclose
MixtureIDLE CUT-OFF
Fuel selectorOFF
Master switchOFF
MagnetosOFF
Flaps.....as situation requires
Directional control.....maintain - make only
shallow turns to avoid obstacles.

If sufficient altitude has been gained to attempt a restart:

Airspeedmaintain above stall
Fuel selectorswitch to other tank
containing fuel
Electric fuel pumpON
MixtureRICH
Carburetor heat.....ON

If power is not regained proceed with power off landing.

ENGINE POWER LOSS IN FLIGHT

Fuel selectorswitch to other tank
containing fuel
Electric fuel pumpON
MixtureRICH
Carburetor heat.....ON
Engine gaugescheck for indication
of cause of power loss
Primer.....locked

If no fuel pressure is indicated, check that fuel selector is on a tank containing fuel.

If power has not been restored:

Ignition switch.....L then R. then back to BOTH
Throttle and mixturetry different settings

When power is restored:

Carburetor heatOFF
Electric fuel pumpOFF

If power cannot be restored:

Trim for best glide angle (70 KIAS) and prepare for power off landing.

POWER OFF LANDING

Trim for best glide angle (70 KIAS).

Locate most suitable landing area.

Establish spiral pattern.

1000 feet above field at downwind position for normal landing approach.

When field can be easily reached, slow to 62 KIAS* or 67 KIAS** for shortest landing with a full stall touchdown. Touchdowns should normally be made at lowest possible airspeed with full flaps.

When committed to landing:

IgnitionOFF
Master switchOFF
Fuel selectorOFF
MixtureIDLE CUT-OFF
Seat belts and harnesstight

FIRE

ENGINE FIRE DURING START

Startercrank engine
MixtureIDLE CUT-OFF
Throttleopen
Electric fuel pumpOFF
Fuel selectorOFF
Abandon airplane if fire continues.

FIRE IN FLIGHT

Source of firecheck

Engine fire:

Fuel selectorOFF
Throttleclosed
MixtureIDLE CUT-OFF
Electric fuel pumpOFF
Cabin heat.....OFF
Defroster.....OFF
Prepare for power off landing.

*Outboard Flow Strips Installed

**Outboard and Inboard Flow Strips Installed

Electrical fire (smoke in cabin):

- Master switchOFF
 - Cabin heat.....OFF
 - Defroster.....OFF
 - Ventsopen to clear cabin
- Land as soon as practicable.

LOSS OF OIL PRESSURE

Land as soon as possible and investigate cause.
Prepare for power off landing.

LOSS OF FUEL PRESSURE

- Electric fuel pumpON
- Fuel selectorcheck on full tank

HIGH OIL TEMPERATURE

Land at nearest airport and investigate the problem.
Prepare for power off landing.

ALTERNATOR FAILURE

- Verify failure
- Reduce electrical load as much as possible.
- Alternator circuit breaker.....check
- Alt switchOFF (for 1 second),
then ON
- If no output:
- Alt switchOFF

Reduce electrical load and land as soon as practical.

SPIN RECOVERY (UNINTENTIONAL SPIN)

- Aileronsneutral
- Rudderfull opposite to
direction of rotation

Control wheel.....full forward
Throttle.....close
Rudder.....neutral (when rotation stops)
Control wheel.....as required to smoothly
regain level flight attitude
Flaps.....retract

OPEN DOOR

If both upper and side latches are open, the door will trail slightly open and airspeeds will be reduced slightly.

To close the door in flight:

Slow airplane to 90 KIAS

Cabin vents.....close

Storm window.....open

If upper latch is open.....latch

If side latch is open.....pull on arm rest while
moving latch handle to
latched position.

If both latches are open.....latch side latch
then top latch

ENGINE ROUGHNESS

Carburetor heat.....ON

If roughness continues after one minute:

Carburetor heat.....OFF

Mixture.....adjust for max. smoothness

Electric fuel pump.....ON

Fuel selector.....switch tanks

Engine gauges.....check

Magneto switch.....L then R, then BOTH

If operation is satisfactory on either one, continue on that magneto at reduced power and full "RICH" mixture to first airport.

Prepare for power off landing.

3.5 AMPLIFIED EMERGENCY PROCEDURES (GENERAL)

The following paragraphs are presented to supply additional information for the purpose of providing the pilot with a more complete understanding of the recommended course of action and probable cause of an emergency situation.

3.7 ENGINE INOPERATIVE PROCEDURES

ENGINE POWER LOSS DURING TAKEOFF (NOT AIRBORNE)

If engine failure occurs before the airplane has lifted off, and if there is sufficient runway left for a safe stop, simply maintain directional control, close the throttle, and brake to a stop.

If there is not sufficient runway remaining for a safe stop, close the throttle, apply maximum braking, pull the mixture control to IDLE CUT-OFF, and turn OFF the fuel selector, the master switch and the magnetos. Maintain directional control, slow the airplane as much as possible, and maneuver to avoid obstacles.

ENGINE POWER LOSS DURING TAKEOFF (IF AIRBORNE)

If engine failure occurs after the airplane has lifted off, and if sufficient landing area remains for a touchdown and stop, lower the nose and maintain airspeed to avoid a stall. Maintain directional control and land and stop straight ahead.

If liftoff has occurred and there is not sufficient landing area remaining for a safe landing and stop, maintain a safe airspeed to avoid a stall. Close the throttle, pull the mixture control to IDLE CUT-OFF, and turn OFF the fuel selector, the master switch, and the magnetos. Use of flaps depends upon the circumstances; however, normally full flaps allow the slowest and softest touchdown.

At low altitudes with a failed engine, turns should not be attempted, except for slight and gentle deviations to avoid obstacles. A controlled crash landing straight ahead is preferable to risking a stall which could result in an uncontrolled roll and crash out of a turn.

If sufficient altitude has been gained to permit a restart attempt, maintain a safe airspeed and switch the fuel selector to another tank containing fuel. Check the electric fuel pump to ensure that it is ON. Check that the mixture control is set RICH and that carburetor heat is ON. If engine failure was caused by fuel exhaustion, power will not be regained after switching tanks until the empty fuel lines are filled. This may require up to ten seconds.

If the propeller has stopped turning, it will be necessary to engage the starter to execute a restart. If power is not regained, proceed with a Power Off Landing.

ENGINE POWER LOSS IN FLIGHT

A complete loss of power is usually caused by a fuel flow interruption, in which case power will be restored shortly after fuel flow is restored. If power loss occurs at a low altitude, the first step should be to prepare for an emergency Power Off Landing. Maintain an airspeed of at least 70 KIAS.

If altitude permits, attempt a restart. Switch the fuel selector to another tank containing fuel. Turn ON the electric fuel pump, set the mixture RICH, and turn ON carburetor heat.

Check the engine gauges for an indication of the cause of the power loss. Be sure that the primer is locked if one is installed. If no fuel pressure is indicated, check the fuel selector to be sure that it is on a tank containing fuel. If fuel exhaustion is the problem, it may take up to ten seconds after switching tanks for empty fuel lines to fill and for power to be restored. If there is water contamination of the fuel, fuel pressure indications will be normal. Water in the fuel could take some time to be passed through, and allowing the propeller to windmill may restore power. If the propeller has stopped turning, engage the starter.

When power is restored and the engine is operating smoothly, turn OFF the carburetor heat and the electric fuel pump.

If the preceding steps do not restore power, prepare for an emergency Power Off Landing. If time permits, try turning the ignition switch to L, then to R, then back to BOTH. Try moving the throttle and mixture controls to various settings. This may restore power if the problem is too rich or too lean a mixture or if there is a partial fuel system restriction.

If power is not regained, proceed with preparations for a Power Off Landing.

POWER OFF LANDING

If loss of power occurs at altitude, trim the airplane for best gliding angle (70 KIAS), and look for a suitable landing area. If the procedures for restoring power are not effective, and if time permits, check charts for airports in the immediate vicinity; it may be possible to reach one if the airplane's altitude is sufficient. If possible, notify the FAA by radio of the situation and intended course of action. If another pilot or a passenger is aboard, that person may assist.

After locating the most suitable landing area, establish a spiral pattern around the field. Try to be at 1000 feet above the field at the downwind position to make a normal landing approach. When assured of reaching the field, slow to 62 KIAS* or 67 BIAS** for the shortest landing. Excess altitude may be lost by widening the pattern, extending flaps, slipping, or a combination of these methods.

Once committed to a landing, shut OFF the ignition, the master switch, and the fuel selector. Pull the mixture to IDLE CUT-OFF. Tighten seat belts and shoulder harness.

Flaps may be used as deemed necessary. Normally a full stall touchdown should be made at the lowest possible airspeed with flaps fully extended.

3.9 FIRE

ENGINE FIRE DURING START

Engine fires during start are usually the result of overpriming. The first step in extinguishing the fire is to cut off the source of fuel and to keep the engine turning to use up excess fuel.

Continue cranking the engine with the starter, while pulling the mixture control to IDLE CUT-OFF and advancing the throttle fully open. Turn OFF the electric fuel pump and the fuel selector. Radio for assistance if possible.

If the engine has started, it should be left running. If the engine is not running, continue cranking with the starter. This is an attempt to draw the fire back into the engine.

*Outboard Flow Strips Installed

**Outboard and Inboard Flow Strips Installed

If the fire continues, leave the fuel selector OFF and the mixture at IDLE CUT-OFF, and abandon the airplane, applying the best external extinguishing means available.

If the fire is on the ground near the airplane, it may be possible to taxi to safety.

FIRE IN FLIGHT

The presence of fire is indicated by smoke, smell, or heat. It is essential that the source of the fire be promptly identified through instrument readings, character of the smoke or other indications, since the action to be taken differs in each case.

If an engine fire is indicated, immediately turn the fuel selector OFF and close the throttle. Pull the mixture control to IDLE CUT-OFF. Be sure that the electric fuel pump is OFF. Turn OFF the cabin heat and defroster. If radio transmission is not required, turn OFF the master switch. Proceed with a Power Off Landing.

NOTE

The possibility of an engine fire in flight is extremely remote. The procedure given is general and pilot judgment should be the determining factor for action in such an emergency.

If smoke or fumes in the cabin indicate an electrical fire, turn OFF the master switch. Turn OFF the cabin heat and defroster, and open the vents to clear smoke and fumes from the cabin. Land as soon as practicable.

NOTES

When the master switch is turned off, the stall warning system will not function.

During night flight a flashlight should be in hand before turning off the master switch.

3.11 LOSS OF OIL PRESSURE

Loss of oil pressure may be either partial or complete. A partial loss of oil pressure usually indicates a malfunction in the oil pressure regulating system, and a landing should be made as soon as possible to allow investigation of the cause and to prevent engine damage.

A complete loss of oil pressure indication may signify oil exhaustion or may be the result of a faulty gauge. In either case, proceed toward the nearest airport, and be prepared for a forced landing. If the problem is not a pressure gauge malfunction, the engine may stop suddenly. Maintain altitude until such time as a power off landing can be accomplished. Do not change power settings unnecessarily, as this may hasten complete power loss.

Depending on the circumstances, it may be advisable to make an off airport landing while power is still available, particularly if other indications of actual oil pressure loss, such as sudden increases in temperatures, or oil smoke, are apparent, and an airport is not close.

If engine stoppage occurs, proceed with Power Off Landing.

3.13 LOSS OF FUEL PRESSURE

If loss of fuel pressure occurs, turn ON the electric fuel pump and check that the fuel selector is on a tank containing fuel.

If the problem is not an empty tank, land as soon as practical and have the engine-driven fuel pump and fuel system checked.

3.15 HIGH OIL TEMPERATURE

An abnormally high oil temperature indication may be caused by a low oil level, an obstruction in the oil cooling installation, damaged or improper baffle seals, a defective gauge, or other causes. Land as soon as possible at an appropriate airport and have the cause investigated.

A steady, rapid rise in oil temperature is a sign of trouble. Land at the nearest airport and let a mechanic investigate the problem. Watch the oil pressure gauge for an accompanying loss of pressure.

3.17 ALTERNATOR FAILURE

Loss of alternator output is detected through zero reading on the ammeter and illumination of the alternator warning light on the instrument panel. Before executing the following procedure, insure that the reading is zero and not merely low by actuating an electrically powered device, such as the landing light. If no increase in the ammeter reading is noted, alternator failure can be assumed.

The electrical load should be reduced as much as possible. Check the alternator circuit breaker for a popped circuit breaker.

The next step is to attempt to reset the overvoltage relay. This is accomplished by turning the ALT switch OFF for one second and then ON. If the trouble was caused by a momentary overvoltage condition (16.5 volts and up), this procedure should return the ammeter to a normal reading.

If the ammeter continues to indicate zero output, or if the alternator will not remain reset, turn off the ALT switch, maintain minimum electrical load and land as soon as practical. All electrical load is being supplied by the battery.

3.19 SPIN RECOVERY (UNINTENTIONAL SPIN)

Intentional spins are permitted only with flaps fully retracted for utility category operation. Should a spin be entered inadvertently, the following procedure should be initiated:

- (a) Neutralize the ailerons.
- (b) Apply and maintain full rudder opposite the direction of rotation.
- (c) As the rudder hits the stop, push the control wheel fully forward. As the stall is broken, relax forward pressure to prevent an excessive airspeed build up.
- (d) Close the throttle.
- (e) As rotation stops, neutralize the rudder and ease back on the control wheel to recover smoothly from the dive.
- (f) Retract the flaps if they have been extended.

NOTES

For more detailed information, see Spins in Section 4 - Normal Procedures.

Inappropriate use of the spin recovery procedure, such as during stall recovery, may induce a spin entry.

3.21 OPEN DOOR

The cabin doors on the Tomahawk are double latched; so the chances of one springing open in flight at both the top and side are remote. However, if improperly latched, a door may spring partially open. This will usually happen at takeoff or soon afterward. A partially open door will not affect normal flight characteristics, and a normal landing can be made with the door open.

If both upper and side latches are open, the door will trail slightly open, and airspeed will be reduced slightly.

To close the door in flight, slow the airplane to 90 KIAS, close the cabin vents and open the storm window. If the top latch is open, latch it. If the side latch is open, pull on the arm rest while moving the latch handle to the latched position. If both latches are open, close the side latch then the top latch.

3.23 ENGINE ROUGHNESS

Engine roughness is usually due to carburetor icing which is indicated by a drop in RPM, and may be accompanied by a slight loss of airspeed or altitude. If too much ice is allowed to accumulate, restoration of full power may not be possible; therefore, prompt action is required.

Turn carburetor heat ON (See Note). RPM will decrease slightly and roughness will increase. Wait for a decrease in engine roughness or an increase in RPM, indicating ice removal. If no change in approximately one minute, return the carburetor heat to OFF.

If the engine is still rough, adjust the mixture for maximum smoothness. The engine will run rough if too rich or too lean. The electric fuel pump should be switched to ON and the fuel selector switched to the other tank to see if fuel contamination is the problem. Check the engine gauges for abnormal readings. If any gauge readings are abnormal, proceed accordingly. Move the magneto switch to L then to R. then back to BOTH. If operation is satisfactory on either magneto, proceed on that magneto at reduced power, with mixture full RICH, to a landing at the first available airport.

If roughness persists, prepare for a precautionary landing at pilot's discretion.

NOTE

Partial carburetor heat may be worse than no heat at all, since it may melt part of the ice, which will refreeze in the intake system. When using carburetor heat, therefore, always use full heat, and when ice is removed return the control to the full cold position.

3.25 LOSS OF PITOT-STATIC PRESSURE

If loss of either pitot or static pressure or both occurs, the alternate source must be used. The control lever located under the left side of the control quadrant should be pushed forward to the open position.

Operation on an alternate static source will cause deviations in the altimeter, rate of climb indicator and airspeed indicator readings. See the correction card mounted on the left side of the control quadrant cover for deviations.

If the problem is in the pitot head or pitot line and is caused by icing or heavy rain conditions, the optional pitot heat may be activated if it is installed. The switch for the heated pitot is located on the electrical switch panel to the left of the control panel. A partially or completely blocked pitot head will give erratic or zero readings on the airspeed indicator.

TABLE OF CONTENTS

SECTION 4

NORMAL PROCEDURES

Paragraph No.		Page No.
4.1	General.....	4-1
4.3	Airspeeds for Safe Operations	4-1
4.5	Normal Procedures Checklist	4-3
	Preflight Check	4-3
	Before Starting Engine.....	4-5
	Engine Start.....	4-5
	Warm Up.....	4-6
	Taxiing	4-7
	Ground Check	4-7
	Before Takeoff	4-7
	Takeoff	4-8
	Climb	4-9
	Cruising.....	4-9
	Approach and Landing.....	4-9
	Stopping Engine.....	4-9
	Parking	4-10
4.7	Amplified Normal Procedures (General).....	4-11
4.9	Preflight Check	4-11
4.11	Before Starting Engine	4-13
4.13	Starting Engine	4-14
4.15	Warm-Up	4-17
4.17	Taxiing	4-17
4.19	Ground Check	4-17
4.21	Before Takeoff.....	4-18
4.23	Takeoff	4-19
4.25	Climb	4-20
4.27	Cruising.....	4-20
4.29	Approach and Landing	4-21
4.31	Stopping Engine.....	4-22

TABLE OF CONTENTS (cont)

SECTION 4 (cont)

Paragraph No.		Page No.
4.33	Parking.....	4-22
4.35	Stalls.....	4-23
4.37	Turbulent Air Operation.....	4-23
4.39	Weight and Balance.....	4-24
4.41	Maneuvers.....	4-24
4.43	Spins.....	4-24

**SECTION 4
NORMAL PROCEDURES**

4.1 GENERAL

This section describes the recommended procedures for the conduct of normal operations for the Tomahawk. All of the required (FAA regulations) procedures and those necessary for the operation of the airplane as determined by the operating and design features of the airplane are presented.

Normal procedures associated with those optional systems and equipment which require handbook supplements are provided by Section 9 (Supplements).

These procedures are provided to present a source of reference and review and to supply information on procedures which are not the same for all aircraft. Pilots should familiarize themselves with the procedures given in this section in order to become proficient in the normal operations of the airplane.

The first portion of this section consists of a short form check list which supplies an action sequence for normal operations with little emphasis on the operation of the systems.

The remainder of the section is devoted to amplified normal procedures which provide detailed information and explanations of the procedures and how to perform them. This portion of the section is not intended for use as an in-flight reference due to the lengthy explanations. The short form check list should be used for this purpose.

4.3 AIRSPEEDS FOR SAFE OPERATIONS

The following airspeeds are those which are significant to the safe operation of the airplane. These figures are for standard airplanes flown at gross weight under standard conditions at sea level.

**SECTION 4
NORMAL PROCEDURES**

**PIPER AIRCRAFT CORPORATION
PA-38-112, TOMAHAWK**

Performance for a specific airplane may vary from published figures depending upon the equipment installed, the condition of the engine, airplane and equipment, atmospheric conditions and piloting technique.

(a) Best Rate Of Climb Speed	70 KIAS
(b) Best Angle of Climb Speed	61 KIAS
(c) Turbulent Air Operating Speed (See CAUTION Subsection 2.3)	103 KIAS
(d) Maximum Flap Speed	89 KIAS
(e) Landing Final Approach Speed	
Full Flaps, 34° (Outboard Flow Strips Installed)	62 KIAS
Full Flaps, 34° (Outboard and Inboard Flow Strips Installed)	67 KIAS
(f) Maximum Demonstrated Crosswind Velocity	15 KTS

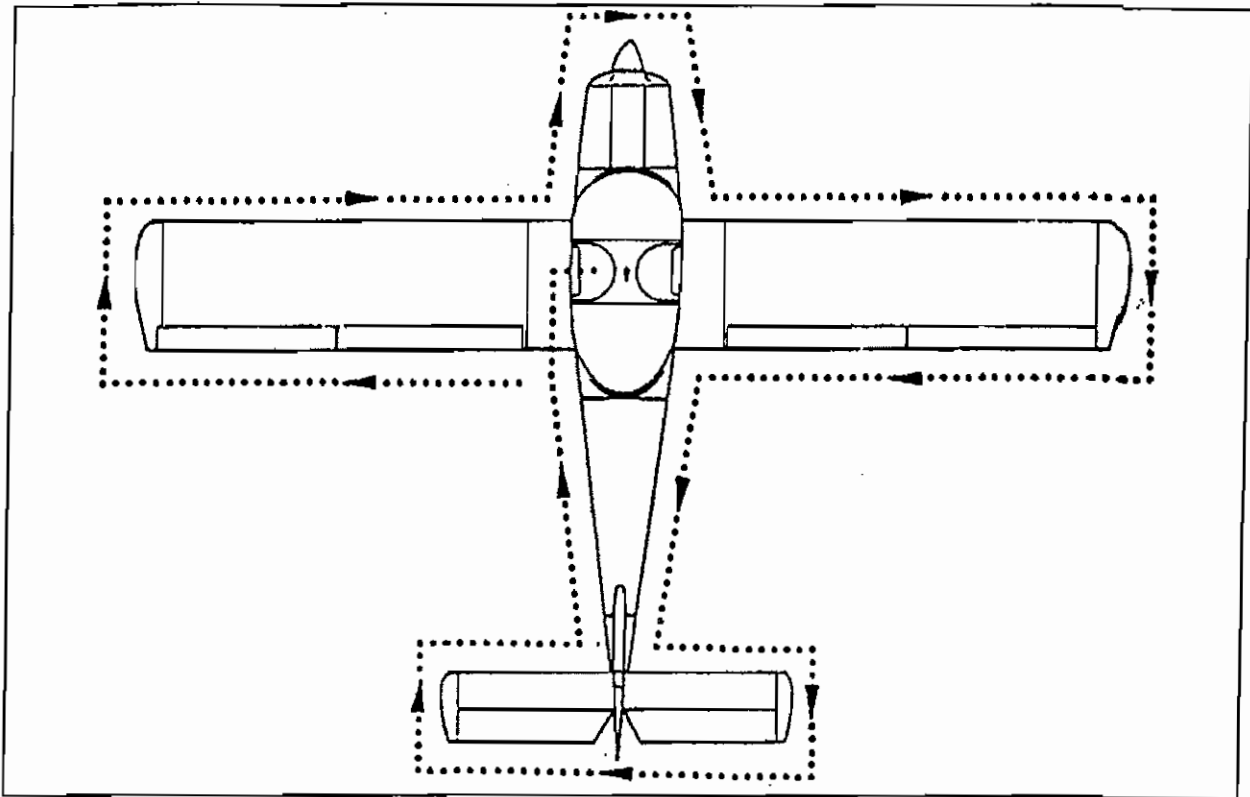

WALK-AROUND
Figure 4-1

4.5 NORMAL PROCEDURES CHECK LIST

PREFLIGHT CHECK

COCKPIT

- Control wheelrelease restraints
- IgnitionOFF
- Master switchON
- Fuel quantity gaugescheck
- Alternator warning lightcheck
- Master switchOFF
- Primary flight controlsproper operation
- Flapsproper operation
- Static draindrained
- Windowscheck clean
- Baggagestowed properly
- Required paperson board
- Parking brakeset ON

LEFT WING

Surface condition.....c check
Flap and hinges.....c check
Aileron and hinges.....c check
Wing tip.....c check
Lightsc check
Fuel cap.....open
Fuel quantity and colorc check
Fuel cap.....close and secure
Fuel ventOpen
Fuel tank sumpdrain
Pitot head.....unobstructed
Stall warning.....check
Landing gear and tire.....check
Brake block and disc.....check
Chock and tie down.....removed

NOSE SECTION

Fuel strainer.....drain
General conditioncheck
Propeller and spinner.....check
Air inletsclear
Engine compartment.....check
Oil.....check quantity
Dipstickproperly seated
Hydraulic fluid level.....check
Alternator beltcheck tension
Cowling.....closed and secure
Nose wheel tire.....check
Nose gear strut.....proper inflation (3 in. exposure)
Windshield.....clean

RIGHT WING

Check as left wing.

FUSELAGE (RIGHT SIDE)

General conditioncheck
Antennas.....check
Side and rear windowclean
Static ventsunobstructed

TAXIING

RadiosON
Taxi area.....clear
Brakes.....check
Steeringcheck

GROUND CHECK

Brakesset
Throttle1 800 RPM
Magnetos.....max. drop 175 RPM - max. diff. 50 RPM
Vacuum5.0" Hg ± .1
Oil temp.....check
Oil pressurecheck
Carburetor heat.....check
Throttle.....retard
Magnetoscheck grounding at low RPM,
then set to BOTH

BEFORE TAKEOFF

Master switch.....check ON
Flight instruments.....check
Fuel selector.....proper tank
Mixture.....set
Electric fuel pump.....ON
Carburetor heat.....OFF
Engine gauges.....check
Static sourcenormal
Seatssecurely latched in track
Seat backserect
Belts/harness.....fastened
Empty seat.....seat belt snugly fastened
Flaps.....set
Trim tab.....set
Controlsfree
Doorsclosed and latched
Overhead latch.....engaged

TAKEOFF

NORMAL

Flaps.....set
Tabset
Accelerate to 53 KIAS.
Control Wheelback pressure to rotate to climb attitude

SHORT FIELD, OBSTACLE CLEARANCE

Flaps21° (first notch)
Accelerate to 53 KIAS.
Control wheelback pressure to rotate to climb attitude
Accelerate to 61 KIAS until obstacle clearance.
Accelerate to 70 KIAS, after obstacle is cleared.
Flaps.....retract slowly

SHORT FIELD, NO OBSTACLE

Flaps21° (first notch)
Accelerate to 53 KIAS.
Control wheelback pressure to rotate to climb attitude
After breaking ground accelerate to best rate of climb speed 70 KIAS.
Flaps.....retract slowly

SOFT FIELD, OBSTACLE CLEARANCE

Flaps21° (first notch)
Accelerate and lift off nose gear as soon as possible.
Lift off at lowest possible airspeed.
Accelerate just above ground to 61 KIAS to climb past obstacle height.
Continue climbing while accelerating to best rate of climb speed, 70 KIAS.
Flaps.....slowly retract

SOFT FIELD, NO OBSTACLE

Flaps21° (first notch)
Accelerate and lift off nose gear as soon as possible.
Lift off at lowest possible airspeed.
Accelerate just above ground to best rate of climb speed, 70 KIAS.
Flaps.....slowly retract

CLIMB

Best rate (flaps up).....70 KIAS
Best angle (flaps up)61 KIAS
Electrical fuel pump.....OFF at desired altitude

CRUISING

Reference performance charts and Avco-Lycoming Operator's Manual.
Normal max power75%
Powerset per power table
Mixture.....adjust

APPROACH AND LANDING

Fuel selector.....proper tank
Seat backserect
Belts/harnessfasten
Electric fuel pump.....ON
Mixture.....set
Flaps.....set - 89 KIAS max
Trim to 70 KIAS.
Final approach speed
 Full flaps (Outboard Flow Strips Installed)62 KIAS
 Full flaps (Outboard and Inboard Flow
 Strips Installed)67 KIAS

STOPPING ENGINE

Flapsretract
Electric fuel pumpOFF
Radios.....OFF
Throttlefull aft
Mixture.....idle cut-off
MagnetosOFF
Master switchOFF

PARKING

Parking brakeset
Control wheelsecured with belt
Flapsfull up
Wheel chocksin place
Tie downsSecure

4.7 AMPLIFIED NORMAL PROCEDURES (GENERAL)

The following paragraphs are provided to supply detailed information and explanations of the normal procedures necessary for the safe operation of the airplane.

4.9 PREFLIGHT CHECK

The airplane should be given a thorough preflight and walk-around check. The preflight should include a check of the airplane's operational status, computation of weight and C.G. limits, takeoff distance and in-flight performance. A weather briefing should be obtained for the intended flight path, and any other factors relating to a safe flight should be checked before takeoff.

COCKPIT

Upon entering the cockpit, release any restraints securing the control wheel. Check that the ignition switch is OFF, that the throttle is closed, and that the mixture control is in idle cut-off. Then turn the master switch ON. Check the fuel quantity gauges for sufficient fuel. Check that the alternator warning light illuminates. After completing these checks, turn the master switch OFF.

Exercise the controls through their full travel and lower and raise the flaps to check for proper operation. The static drain valve on the lower left sidepanel should be opened and drained. Check for unobstructed visibility and clean windows. See that the baggage is stowed properly and tied down. Make sure that all necessary charts and papers are on board and in order. Before leaving the cockpit for the external check, set the parking brake.

LEFT WING

Check that the wings and control surfaces are free of snow, ice, frost or any other foreign matter. Check for damage and loose screws or rivets. Check the control surfaces and hinges for damage and operational interference. Check the wing tip and lights for damage.

Open the fuel cap and visually check the fuel for color and quantity. Replace the fuel cap securely after the check is complete. Be sure that the fuel tank vent is unobstructed. Using the underwing fuel tank drain, drain sufficient fuel from the tank to ensure the removal of contaminants. It is

recommended that drained fuel be collected in a suitable container, examined, and then discarded. After this procedure be sure that the drain valve is closed and that fuel is not dripping.

CAUTION

When draining any amount of fuel, care should be taken that no fire hazard exists before starting engine.

If a pitot head cover has been attached, remove it, and ensure that the holes are open and unobstructed. Check that the stall warning lift detector moves freely.

Check the landing gear. The strut should be sound and securely attached. Brake blocks and discs should show no signs of damage or excessive wear, and the brake line should be securely attached and show no signs of leakage. The tire should not be damaged or excessively worn and should be properly inflated. Proper inflation is 30 psi for aircraft equipped with 6.00 x 6 main wheels and 26 psi for 5.00 x 5. If chocks or tie-downs have been employed, they should be removed before any attempt is made to move the airplane.

NOSE SECTION

Drain and examine fuel from the fuel strainer on the left side of the nose section. The fuel strainer should be drained twice, once with the fuel selector valve on each tank setting. Check the general condition of the nose section and look for suspicious oil or fluid leakage. The propeller and spinner should be checked for detrimental nicks, cracks, dents or other defects. Check the engine breather tube for obstructions. Check all openings and air inlets for debris, bird nests or other obstructions.

Open each side of the engine cowling. Wires and lines should be attached securely. The engine should be relatively clean, as grease and dirt in the engine compartment not only hinder examination and service but also present a fire hazard. Check the oil level, then replace the dipstick, ensuring that it is firmly seated. Check the hydraulic fluid level and replace and secure the cap. Check the condition and tension of the alternator belt. Check the oil filter cooling ducts for obstructions. Close and latch the cowling securely.

Check the condition of the nose wheel tire. Proper inflation is 30 psi for aircraft equipped with a 6.00 x 6 nose wheel and 26 psi for a 5.00 x 5. The

control lever to idle cut-off and engage the starter by rotating the magneto switch clockwise. When the engine fires, release the magneto switch, advance the mixture and retard the throttle.

(d) Starting Engine With External Power Source*

An optional external power receptacle allows the operator to use an external battery to crank the engine without having to gain access to the airplane's battery.

Turn the master switch OFF and turn all electrical equipment OFF. Connect the RED lead of the external power cable to the POSITIVE (+) terminal of an external 12-volt battery and the BLACK lead to the NEGATIVE (-) terminal. Insert the plug of the jumper cable into the socket located on the fuselage. Note that when the plug is inserted, the electrical system is ON. Proceed with the normal starting technique.

After the engine has started, reduce power to the lowest possible RPM, to reduce sparking, and disconnect the jumper cable from the aircraft. Turn the master switch ON and check the alternator ammeter for an indication of output. DO NOT ATTEMPT FLIGHT IF THERE IS NO INDICATION OF ALTERNATOR OUTPUT.

NOTE

For all normal operations using the external power cables, the master switch should be OFF, but it is possible to use the ship's battery in parallel by turning the master switch ON. This will give longer cranking capabilities, but will not increase the amperage.

CAUTION

A dead or depleted aircraft battery should not be charged in the aircraft.

*Optional

When the engine is firing evenly, advance the throttle to 800 RPM. If oil pressure is not indicated within thirty seconds, stop the engine and determine the trouble. In cold weather it will take a few seconds longer to get an oil pressure indication. To check the operation of the engine driven fuel pump, turn OFF the electric fuel pump and check the fuel pressure. If the engine has failed to start, refer to the Lycoming Operating Handbook Engine Troubles and Their Remedies.

Starter manufacturers recommend that cranking periods be limited to thirty seconds with a two minute rest between cranking periods. Longer cranking periods will shorten the life of the starter.

4.15 WARM-UP

Warm-up the engine at 800 to 1200 RPM for not more than two minutes in warm weather and four minutes in cold. Avoid prolonged idling at low RPM, as this practice may result in fouled spark plugs.

Takeoff may be made as soon as the ground check is completed and the engine is warm.

Do not operate the engine at high RPM when running up or taxiing over ground containing loose stones, gravel or any loose material that may cause damage to the propeller blades.

4.17 TAXIING

Before ground personnel attempt to taxi the airplane, they should be instructed and approved by a qualified person authorized by the owner. Ascertain that the propeller back blast and taxi areas are clear.

Power should be applied slowly to start the taxi roll. Taxi a few feet forward and apply the brakes to determine their effectiveness. While taxiing, make slight turns to ascertain the effectiveness of the steering.

Observe wing clearances when taxiing near buildings or other stationary objects. If possible, station an observer outside the airplane.

Avoid holes and ruts when taxiing over uneven ground.

Do not operate the engine at high RPM when running up or taxiing over ground containing loose stones, gravel or any loose material that may cause damage to the propeller blades.

4.19 GROUND CHECK

Set the parking brake. The magnetos should be checked at 1800 RPM. Drop off on either magneto should not exceed 175 RPM and the difference between the magnetos should not exceed 50 RPM. Do not operate on a single magneto for too long a period, 2 to 3 seconds is usually sufficient to check drop off and will minimize plug fouling.

NOTE

Avoid engagement of starter or turning the switch to off when performing magneto check.

Check the vacuum gauge; the indicator should read 5.0" \pm .1" Hg at 2000 RPM.

Carburetor heat should also be checked prior to takeoff to be sure the control is operating properly and to clear any ice which may have formed during taxiing. Avoid prolonged ground operation with carburetor heat ON as the air is unfiltered.

Prior to takeoff the electric pump should be turned ON again to prevent loss of power during takeoff should the engine driven pump fail. Check both oil temperature and oil pressure. The temperature may be low for some time if the engine is being run for the first time of the day.

To check magneto grounding, retard the throttle to IDLE between 550 and 650 RPM and turn the magneto switch OFF, and immediately back to BOTH. If the magnetos are properly grounded, the engine will stop firing when the switch is in the OFF position.

4.21 BEFORE TAKEOFF

All aspects of each particular takeoff should be considered prior to executing the takeoff procedure.

Check that the master switch is ON, and check and set all of the flight instruments as required. Check the fuel selector to make sure it is on the proper tank (fullest). Set the mixture; turn ON the electric fuel pump and check the engine gauges. The carburetor heat should be in the OFF position.

NOTE

The mixture should be set to FULL RICH but a minimum amount of leaning is permitted for smooth engine operation when taking off at high elevation.

After adjusting the seat for pilot comfort, check to be sure that the seat is securely latched by the two locking pins in the floor track by pushing back and forth.

Both seat backs should be erect, and the seat belts and shoulder harness should be fastened. Fasten the seat belts snugly around an empty seat.

Exercise and set the flaps and trim tab. Insure proper flight control movement and response. Both doors should be properly secured and latched.

4.23 TAKEOFF

NORMAL

For takeoff, the elevator tab should be set slightly aft of neutral, with the exact setting determined by the loading of the airplane. Allow the airplane to accelerate to 53 KIAS, and ease back on the control wheel just enough to rotate to climb attitude. Premature or excessive raising of the nose will result in a delayed takeoff. After takeoff, let the airplane accelerate to the desired climb speed by lowering the nose slightly. Trying to pull the airplane off the ground at too low an airspeed decreases controllability in the event of an engine failure.

Normally, flaps are left up for takeoffs; however for short field takeoffs and for takeoffs under such conditions as deep grass or a soft surface, total distances can be reduced appreciably by lowering the flaps one notch and rotating at a lower airspeed.

SHORT FIELD, OBSTACLE CLEARANCE

Lower the flaps one notch and apply full power before brake release. Accelerate to 53 KIAS, and ease back on the control wheel just enough to rotate. Maintain the best angle of climb speed, 61 KIAS, until the obstacle has been cleared. After obstacle clearance, accelerate to the best rate of climb speed, 70 KIAS, and slowly retract the flaps and continue to climb.

SHORT FIELD, NO OBSTACLE

Lower the flaps one notch and apply full power before brake release. Accelerate to 53 KIAS, and ease back on the control wheel just enough to rotate. After breaking ground, accelerate to the best rate of climb speed, 70 KIAS, and slowly retract the flaps while climbing out.

SOFT FIELD, OBSTACLE CLEARANCE

Lower the flaps one notch. Apply power with brakes released. Ease back on the control wheel just enough to raise the nose wheel from the ground as soon as possible, and lift off at the lowest possible airspeed. Accelerate just above the ground to the best angle of climb speed, 61 KIAS, to climb past the obstacle. After obstacle clearance, accelerate to the best rate of climb speed, 70 KIAS, and slowly retract the flaps and continue to climb.

SOFT FIELD, NO OBSTACLE

Lower the flaps one notch. Apply power with brakes released. Ease back on the control wheel just enough to raise the nose wheel from the ground as soon as possible, and lift off at the lowest possible airspeed. Accelerate just above the ground to the best rate of climb speed, 70 KIAS. Slowly retract the flaps while climbing out.

4.25 CLIMB

The best rate of climb at gross weight will be obtained at 70 KIAS. The best angle of climb may be obtained at 61 KIAS. At lighter than gross weight these speeds are reduced somewhat.

When reaching the desired altitude, the electric fuel pump should be turned off, and the fuel pressure checked.

4.27 CRUISING

The cruising speed is determined by many factors, including power setting, altitude, temperature, loading and equipment installed in the airplane.

The normal maximum cruising power is 75% of the rated horsepower of the engine. Airspeeds, which may be obtained at various altitudes, and power settings can be determined from the performance graphs provided by Section 5.

Use of the mixture control in cruising flight reduces fuel consumption significantly, especially at higher altitudes, and also reduces lead deposits when the alternate fuels are used. During letdown and low power flight operations, it may be necessary to lean because of excessively rich mixture.

The mixture should be leaned during cruising operation when 75% power or less is being used. If any doubt exists as to the amount of power being used, the mixture should be in the FULL RICH position for all operations. Always enrich the mixture before increasing power settings.

To lean the mixture, pull the mixture control until the engine becomes rough, indicating that the lean mixture limit has been reached in the leaner cylinders. Then enrich the mixture by pushing the control toward the instrument panel until engine operation becomes smooth. When leaning, carefully observe the temperature instruments.

Always remember that the electric fuel pump should be turned ON before switching tanks, and should be left on for a short period thereafter. In order to keep the airplane in best lateral trim during cruising flight, the fuel should be used alternately from each tank. It is recommended that one tank be used for one hour after takeoff, then the other tank be used for two hours; then return to the first tank. Do not run tanks completely dry in flight. The electric fuel pump should be normally OFF so that any malfunction of the engine-driven fuel pump is immediately apparent. If signs of fuel starvation should occur at any time during flight, fuel exhaustion should be suspected, at which time the fuel selector should be immediately positioned to the other tank and the electric fuel pump switched to the ON position.

4.29 APPROACH AND LANDING

Check to insure that the fuel selector is on the proper (fullest) tank and that the seat backs are erect. The seat belts and shoulder harness should be fastened and the inertia reel checked.

Turn the electric fuel pump ON. The mixture should be set in the full RICH position.

The airplane should be trimmed to an initial-approach speed of about 70 KIAS with a final-approach speed of 62 KIAS* or 67 KIAS** with flaps extended fully. The flaps can be lowered at speeds up to 89 KIAS, if desired.

The mixture control should be kept in full RICH position to insure maximum acceleration if it should be necessary to open the throttle again. Carburetor heat should not be applied unless there is an indication of

*Outboard Flow Strips Installed

**Outboard and Inboard Flow Strips Installed

carburetor icing, since the use of carburetor heat causes a reduction in power which may be critical in case of a go-around. Full throttle operation with carburetor heat on can cause detonation.

The amount of flap used during landings and the speed of the aircraft at contact with the runway should be varied according to the landing surface and conditions of wind and airplane loading. It is generally good practice to contact the ground at the minimum possible safe speed consistent with existing conditions.

Normally, the best technique for short and slow landings is to use full flap and enough power to maintain a safe airspeed and approach flight path. Mixture should be full RICH, fuel on the fullest tank, and electric fuel pump ON. Reduce the speed during the flareout and contact the ground close to the stalling speed. After ground contact hold the nose wheel off as long as possible. As the airplane slows down, gently lower the nose and apply the brakes. For short field landings braking is most effective when flaps are raised and back pressure is applied to the control wheel, putting most of the aircraft weight on the main wheels. In high wind conditions, particularly in strong crosswinds, it may be desirable to approach the ground at higher than normal speeds with partial or no flaps.

4.31 STOPPING ENGINE

At the pilot's discretion, the flaps should be raised and the electric fuel pump turned OFF. The radios should be turned OFF, and the engine stopped by pulling the mixture control back to the idle cut-off. The throttle should be left full aft to avoid engine vibration while stopping. After the engine has stopped the magneto and master switches must be turned OFF.

NOTE

When alternate fuels are used, the engine should be run up to 1200 RPM for one minute prior to shutdown to clean out any unburned fuel.

4.33 PARKING

If necessary, the airplane should be moved on the ground with the aid of a nose wheel tow bar. The aileron and stabilator controls should be secured by looping the safety belt through the control wheel and pulling it snug.

Tie downs can be secured to rings provided under each wing and to the tail skid. The rudder is held in position by its connections to the nose wheel steering and normally does not have to be secured.

4.35 STALLS

An approaching stall is indicated by a stall warning horn which is activated between five and ten knots above stall speed. Mild airframe buffeting and gentle pitching may also precede the stall.

The stalling speed at 1670 lbs. gross weight with power off, outboard flow strips installed, and full flaps is 47 KIAS, with flaps up this speed is increased 1 knot; with both outboard and inboard flow strips installed and full flaps the stall speed is 49 KIAS, with flaps up this speed is increased 3 knots. Loss of altitude during stalls can be as great as 320 feet, depending on configuration and power.

NOTE

The stall warning system is inoperative with the master switch OFF.

During preflight, the stall warning system should be checked by turning the master switch ON, lifting the detector and checking to determine if the horn is actuated. The master switch should be returned to the OFF position after the check is complete.

4.37 TURBULENT AIR OPERATION

In keeping with good operating practice used in all aircraft, it is recommended that when turbulent air is encountered or expected, the airspeed be reduced to maneuvering speed to reduce the structural loads caused by gusts and to allow for inadvertent speed build-ups which may occur as a result of the turbulence or of distractions caused by the conditions (See Subsection 2.3). Flight into thunderstorms or severe turbulence should be avoided.

4.39 WEIGHT AND BALANCE

It is the responsibility of the pilot and aircraft owner to determine that the airplane remains within the allowable weight vs. center of gravity envelope while in flight.

For weight and balance data, refer to Section 6 (Weight and Balance).

4.41 MANEUVERS

The airplane is approved for certain acrobatic maneuvers, provided it is loaded within the approved weight and center of gravity limits (See Section 2 - Limitations). The approved maneuvers are spins, steep turns, lazy eights, and chandelles.

Intentional spins are prohibited in the normal category airplane. Lazy eights and chandelles may be performed in the normal category provided a 60 degree angle of bank and/or a 30 degree angle of pitch is not exceeded. For approved maneuvers and entry speed, refer to Section 2 - Limitations.

4.43 SPINS

The airplane is approved for intentional spinning when the flaps are fully retracted.

BEFORE SPINNING

Carrying baggage during the spin is prohibited and the pilot should make sure that all loose items in the cockpit are removed or securely stowed including the second pilot's seat belts if the aircraft is flown solo. Seat belts and shoulder harnesses should be fastened securely and the seat belts adjusted first to hold the occupants firmly into the seats before the shoulder harness is tightened. With the seat belts and shoulder harnesses tight, check that the position of the pilots' seats allow full rudder travels to be obtained and both full back and full forward control wheel movements. Finally check that the seats are securely locked in position. Spins should only be started at altitudes high enough to recover fully by at least 4,000 feet AGL, so as to provide an adequate margin of safety. A one-turn spin, properly executed, will require 1,000 to 1,500 feet to complete and a six-turn spin will require 2,500 to 3,000 feet to complete. The airplane should be trimmed in a power-off glide at approximately 75 knots before entering the stall prior to spinning. This trim airspeed assists in achieving a good balance between airspeed and "g" loads in the recovery dive.

SPIN ENTRY

The spin should be entered from a power-off glide by reducing speed at about 1 kt/sec until the airplane stalls. Apply full aft control wheel and full rudder in the desired spin direction. This control configuration with the throttle closed should be held throughout the spin. The ailerons must remain neutral throughout the spin and recovery, since aileron application may alter the spin characteristics to the degree that the spin is broken prematurely or that recovery is delayed.

SPIN RECOVERY

- (a) Apply and maintain full rudder opposite the direction of rotation.
- (b) As the rudder hits the stop, rapidly move the control wheel full forward and be ready to relax the forward pressure as the stall is broken.
- (c) As rotation stops, centralize the rudder and smoothly recover from the dive.

Normal recoveries may take up to 1-1/2 turns when proper technique is used; improper technique can increase the turns to recover and the resulting altitude loss.

FURTHER ADVICE ON SPINNING

SPIN ENTRY

Application of full aft control wheel and full rudder before the airplane stalls is not recommended as it results in large changes in pitch attitude during entry and the first turn of the spin. Consequently the initial 2-3 turns of the spin can be more oscillatory than when the spin is entered at the stall.

SPIN RECOVERY

The recommended procedure has been designed to minimize turns and height loss during recovery. If a modified recovery is employed (during which a pause of about 1 second - equivalent to about one half turn of the spin - is introduced between the rudder reaching the stop and moving the control column forward) spin recovery will be achieved with equal certainty. However the time taken for recovery will be delayed by the length of the pause, with corresponding increase in the height lost.

In all spin recoveries the control column should be moved forward briskly, continuing to the forward stop if necessary. This is vitally important because the steep spin attitude may inhibit pilots from moving the control column forward positively.

The immediate effect of applying normal recovery controls may be an appreciable steepening of the nose down attitude and an increase in rate of spin rotation. This characteristic indicates that the aircraft is recovering from the spin and it is essential to maintain full anti-spin rudder and to continue to move the control wheel forward and maintain it fully forward until the spin stops. The airplane will recover from any point in a spin in not more than one and one half additional turns after normal application of controls.

MISHANDLED RECOVERY

The airplane will recover from mishandled spin entries or recoveries provided the recommended spin recovery procedure is followed. Improper application of recovery controls can increase the number of turns to recover and the resulting altitude loss.

Delay of more than about 1-1/2 turns before moving the control wheel forward may result in the aircraft suddenly entering a very fast, steep spin mode which could disorient a pilot. Recovery will be achieved by briskly moving the control wheel fully forward and holding it there while maintaining full recovery rudder.

If such a spin mode is encountered, the increased rate of rotation may result in the recovery taking more turns than usual after the control column has been moved fully forward.

In certain cases the steep, fast spin mode can develop into a spiral dive in which the rapid rotation continues, but indicated airspeed increases slowly. It is important to recognize this condition. The aircraft is no longer auto-rotating in a spin and the pilot must be ready to centralize the rudder so as to ensure that airspeed does not exceed 103 kt (V_A) with full rudder applied.

DIVE OUT

In most cases spin recovery will occur before the control wheel reaches the fully forward position. The aircraft pitches nose down quickly when the elevator takes effect and, depending on the control column position, it may be necessary to move the column partially back almost immediately to avoid an unnecessarily steep nose down attitude, possible negative "g" forces and excessive loss of altitude.

Because the aircraft recovers from a spin in a very steep nose-down attitude, speed builds up quickly in the dive out. The rudder should be centralized as soon as the spin stops. Delay in centralizing the rudder may

result in yaw and "fish-tailing." If the rudder is not centralized it would be possible to exceed the maximum maneuver speed (V_A) of 103 kt with the surface fully deflected.

ENGINE

Normally the engine will continue to run during a spin, sometimes very slowly. If the engine stops, take normal spin recovery action, during which the propeller will probably windmill and restart the engine. If it does not, set-up a glide at 75 kt and restart using the starter motor.

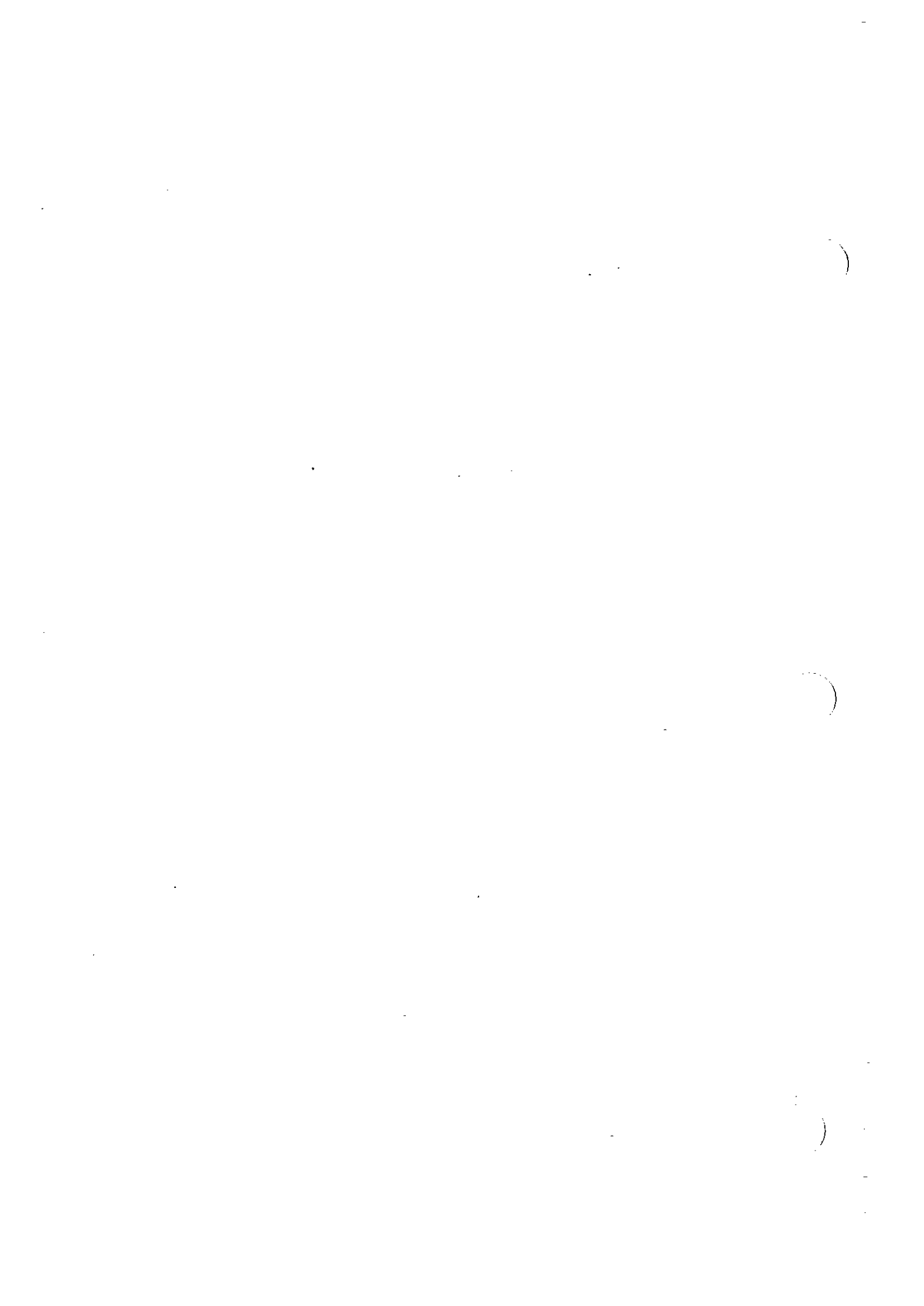

nose gear strut should show no sign of fluid leakage and should be inflated to show 3 inches of strut exposure. Clean and check the windshield. Remove the nose wheel chock if one has been employed.

RIGHT WING

Check the right wing using the same procedure as performed on the left wing.

FUSELAGE (RIGHT SIDE)

Check the general condition of the fuselage. Check that all antenna access panels are in place and securely attached. Be sure that the side and rear windows are clean. Check that the openings in the static pad are clean and unobstructed.

EMPENNAGE

Surfaces of the empennage should be examined for damage and operational interference. Check all visible and accessible hinges and attachments. Remove the tie-down if one has been employed.

FUSELAGE (LEFT SIDE)

Check the left side of the fuselage using the same procedure as performed on the right.

When the stall warning device and the optional pitot heat and navigation lights, if installed, are to be checked for proper functioning, turn ON the master switch and the appropriate electrical switches. Visually confirm that exterior lights are operational. Lift the stall detector on the left wing and observe that the warning horn sounds. Check the pitot heat by carefully feeling the pitot head. Use caution as the head can become extremely hot. When these checks are complete, return the master switch and the electrical switches to their OFF positions.

4.11 BEFORE STARTING ENGINE

After entering the cockpit and before starting the engine, close and latch both cabin doors, securing the main latch first, and then engaging the overhead latch. If a door is to be left open, in warm weather for example, the latching procedure must be completed before takeoff.

Seats should be positioned for best comfort and visibility. Be sure that the seats are securely latched in the tracks. Fasten seat belts and harnesses. Check that all circuit breakers are in. Exercise the throttle and mixture levers through their full travel to ensure that they operate smoothly. Set the parking brake; check that the carburetor heat control is fully OFF; and set the fuel selector lever to the desired tank position.

4.13 STARTING ENGINE

(a) Starting Engine When Cold

Prime using two to four strokes for starts when the temperature is +40° F. Use more primer strokes for colder temperatures. On the last priming stroke, leave the primer in the out position. Throttle should be set 1/2 inch open. Turn ON the master switch and the electric fuel pump. Move the mixture control to full RICH and engage the starter by rotating the magneto switch clockwise. When the engine fires, release the magneto switch, and push the primer in slowly to keep engine running. Advance the throttle slightly and lock primer.

NOTE

This engine does not have an accelerator pump in the carburetor; thus, pumping the throttle will not aid in starting.

If the engine does not fire within ten seconds, disengage the starter, wait thirty seconds, and repeat the starting procedure.

(b) Starting Engine When Hot

Close the throttle. Turn ON the master switch and the electric fuel pump. Move the mixture control lever to full RICH and engage the starter by rotating the magneto switch clockwise. When the engine fires, release the magneto switch and move the throttle to the desired setting. If the engine does not start, open the throttle 1/2 inch and try again.

(c) Starting Engine When Flooded

The throttle lever should be full OPEN. Turn ON the master switch and turn OFF the electric fuel pump. Move the mixture

TABLE OF CONTENTS

SECTION 5

PERFORMANCE

Paragraph No.		Page No.
5.1	General.....	5-1
5.3	Introduction - Performance and Flight Planning	5-1
5.5	Flight Planning Example	5-3
5.7	Performance Graphs	5-9
	List of Figures.....	5-9

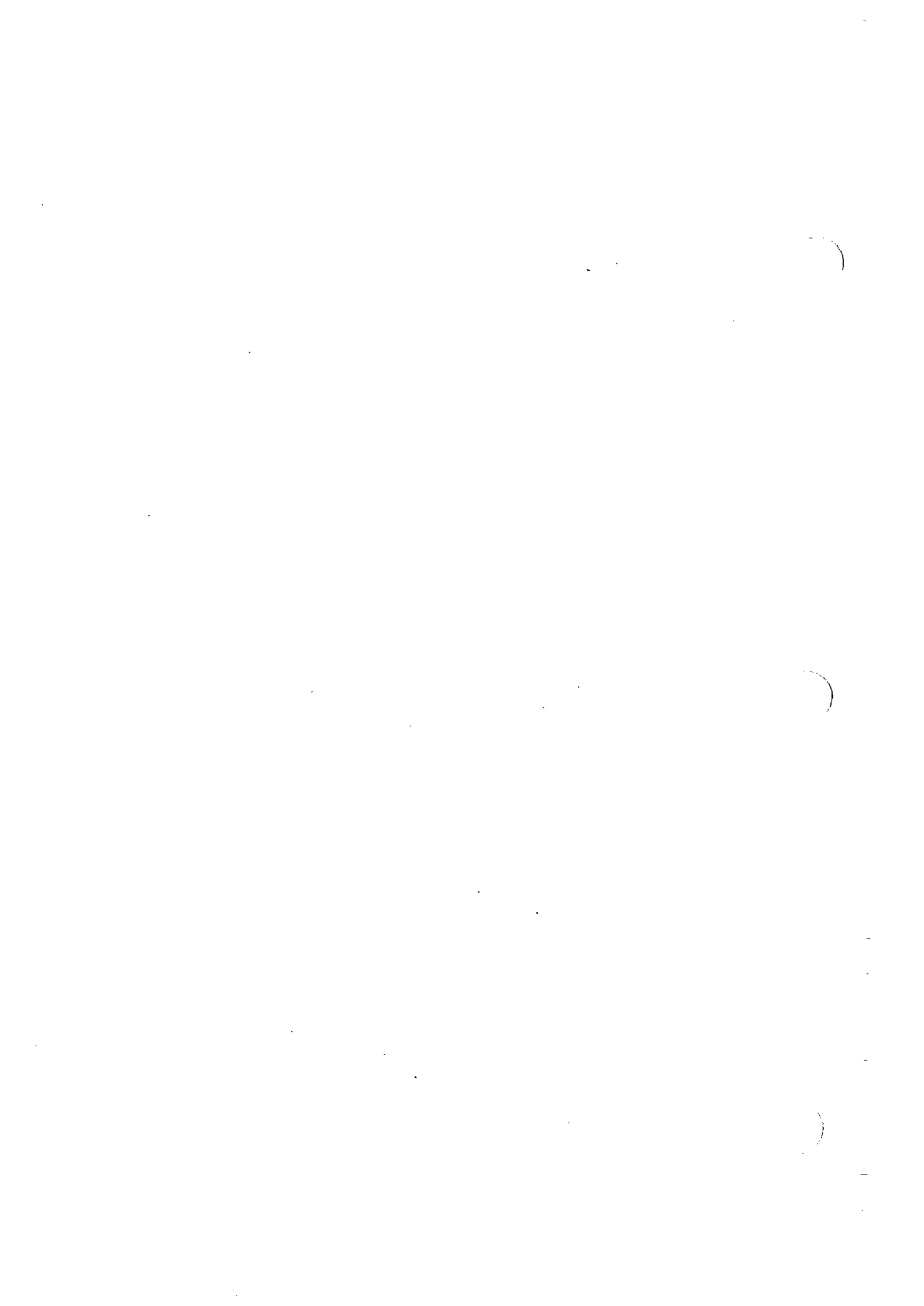

**SECTION 5
PERFORMANCE**

5.1 GENERAL

All of the required (FAA regulations) and complementary performance information applicable to this aircraft is provided by this section.

Performance information associated with those optional systems and equipment which require handbook supplements is provided by Section 9 (Supplements).

5.3 INTRODUCTION - PERFORMANCE AND FLIGHT PLANNING

The performance information presented in this section is based on measured Flight Test Data corrected to I.C.A.O. standard day conditions and analytically expanded for the various parameters of weight, altitude, temperature, etc.

The performance charts are for the standard production aircraft configuration. The data is unfactored and does not make any allowance for varying degrees of pilot proficiency or mechanical deterioration of the aircraft. This performance, however, can be duplicated by following the stated procedures in a properly maintained airplane. Those aircraft equipped with 6.00 x 6 TIRE/WHEEL ASSEMBLIES will exhibit climb rates approximately 15 fpm lower than chart values and cruise speeds 2 to 3 knots below chart values. Range will be correspondingly decreased.

Effects of conditions not considered on the charts must be evaluated by the pilot, such as the effect of soft or grass runway surface on takeoff and landing performance, or the effect of winds aloft on cruise and range performance. Endurance can be grossly affected by improper leaning procedures, and inflight fuel flow and quantity checks are recommended.

REMEMBER! To get chart performance, follow the chart procedures.

The information provided by paragraph 5.5 (Flight Planning Example) outlines a detailed flight plan using the performance charts in this section. Each chart includes its own example to show how it is used.

WARNING

Performance information derived by extrapolation beyond the limits shown on the charts should not be used for flight planning purposes.

5.5 FLIGHT PLANNING EXAMPLE

(a) Aircraft loading

The first step in planning a flight is to calculate the airplane weight and center of gravity by utilizing the information provided by Section 6 (Weight and Balance) of this handbook.

The basic empty weight for the airplane as licensed at the factory has been entered in Figure 6-7. If any alterations to the airplane have been made affecting weight and balance, refer to the aircraft logbook and Weight and Balance Record (Figure 6-9) to determine the current basic empty weight of the airplane.

Use the Weight and Balance Loading Form (Figure 6-13) and the C.G. Range and Weight graph (Figure 6-17) to determine the total weight of the airplane and the center of gravity position.

After proper utilization of the information provided, the following weights are to be considered in the flight planning example.

The landing weight cannot be determined until the weight of the fuel to be used has been established [refer to item (g) (1)].

(1) Basic Empty Weight	1144 lbs.
(2) Occupants (2 x 170 lbs.)	340 lbs.
(3) Baggage and Cargo	0 lbs.
(4) Fuel (6 lb/gal x 30)	180 lbs.
(5) Takeoff Weight	1664 lbs.
(6) Landing Weight	
(a)(5) minus (g)(1), (1664 lbs. minus 99.9 lbs.)	1564.1 lbs.

The takeoff weight is below the maximum of 1670 lbs. and the weight and balance calculations have determined the C.G. position is within the approved limits.

(b) Takeoff and Landing

Now that the aircraft loading has been determined, all aspects of takeoff and landing must be considered.

All of the existing conditions at the departure and destination airport must be acquired, evaluated and maintained throughout the flight.

Apply the departure airport conditions and takeoff weight to the appropriate Takeoff Performance graph (Figures 5-5 and 5-7 or 5-9 and 5-11) to determine the length of runway necessary for the takeoff and/or the barrier distance.

The landing distance calculations are performed in the same manner using the existing conditions at the destination airport and, when established, the landing weight.

The conditions and calculations for the example flight are listed below. The takeoff and landing distances required for the example flight have fallen well below the available runway lengths.

	Departure Airport	Destination Airport
(1) Pressure Altitude	1100 ft.	800 ft.
(2) Temperature	8°C	13°C
(3) Wind Component	10 KTS (Headwind)	2 KTS (Tailwind)
(4) Runway Length Available	4800 ft.	7600 ft.
(5) Runway Required	1320 ft.*	1600**

NOTE

The remainder of the performance charts used in this flight plan example assume a no wind condition. The effect of winds aloft must be considered by the pilot when computing climb, cruise and descent performance.

*reference figure 5-7

**reference figure 5-37

(c) Climb

The next step in the flight plan is to determine the necessary climb segment components.

The desired cruise pressure altitude and corresponding cruise outside air temperature values are the first variables to be considered in determining the climb components from the Fuel, Time and Distance to Climb graph (Figure 5-15). After the fuel, time and distance for the cruise pressure altitude and outside air temperature values have been established, apply the existing conditions at the departure field to graph (Figure 5-15). Now, subtract the values obtained from the graph for the field of departure conditions from those for the cruise pressure altitude.

The remaining values are the true fuel, time and distance components for the climb segment of the flight plan corrected for field pressure altitude and temperature.

The following values were determined from the above instructions in our flight planning example.

(1) Cruise Pressure Altitude	3300 ft.
(2) Cruise OAT	3°C
(3) Time to Climb (4 min. minus 1 min.)	3 min.
(4) Distance to Climb (5 miles minus 1 mile)	4 Miles*
(5) Fuel to Climb (.6 gal. minus .2 gal.)	.4 gal.*

(d) Descent

The descent data will be determined prior to the cruise data to provide the descent distance for establishing the total cruise distance.

Utilizing the cruise pressure altitude and OAT, determine the basic fuel, time and distance for descent (Figure 5-31). These figures must be adjusted for the field pressure altitude and temperature at the destination airport. To find the necessary adjustment values, use the existing pressure altitude and temperature conditions at the

*reference Figure 5-15

destination airport as variables to find the fuel, time and distance values from the graph (Figure 5-31). Now, subtract the values obtained from the field conditions from the values obtained from the cruise conditions to find the true fuel, time and distance values needed for the flight plan.

The values obtained by proper utilization of the graphs for the descent segment of our example are shown below.

- | | |
|--|-----------|
| (1) Time to Descend
(3.5 min. minus 1 min.) | 2.5 min.* |
| (2) Distance to Descend
(7 miles minus 2 miles) | 5 miles* |
| (3) Fuel to Descend
(.25 gal. minus .1 gal.) | .15 gal.* |

(e) Cruise

Using the total distance to be traveled during the flight, subtract the previously calculated distance to climb and distance to descend to establish the total cruise distance. Refer to Figure 5-17 when selecting the cruise power setting. The established pressure altitude and temperature values and the selected cruise power should now be utilized to determine the true airspeed from the Speed Power graph (Figures 5-19 or 5-21).

Calculate the cruise fuel flow for the cruise power setting from the information provided in Figures 5-19 or 5-21.

The cruise time is found by dividing the cruise distance by the cruise speed, and the cruise fuel is found by multiplying the cruise fuel flow by the cruise time.

The cruise calculations established for the cruise segments of the flight planning example are as follows:

- | | |
|--|-----------------|
| (1) Total Distance | 300 miles |
| (2) Cruise Distance
(e)(1) minus (c)(4) minus (d)(2),
(300 miles minus 4 miles minus
5 miles) | 291 miles |
| (3) Cruise Power, Best Economy
Mixture | 65% rated power |

*reference Figure 5-31

(4) Cruise Speed	88.5 KTS TAS*
(5) Cruise Fuel	4.9 GPH
(6) Cruise Time	
(e)(2) divided by (e)(4), (291 miles divided by 88.5 KTS)	3.29 hrs.
(7) Cruise Fuel	
(e)(5) multiplied by (e)(6), (4.9 GPH multiplied by 3.29 hrs.)	16.1 gal.

(f) Total Flight Time

The total flight time is determined by adding the time to climb, the time to descend and the cruise time. Remember! The time values taken from the climb and descent graphs are in minutes and must be converted to hours before adding them to the cruise time.

The following flight time is required for the flight planning example.

(1) Total Flight Time	
(c)(3) plus (d)(1) plus (e)(6), (.05 hrs. plus .04 hrs. plus 3.29 hrs.)	3.38 hrs.

(g) Total Fuel Required

Determine the total fuel required by adding the fuel to climb, the fuel to descend and the cruise fuel. When the total fuel (in gallons) is determined, multiply this value by 6 lb/gal to determine the total fuel weight used for the flight.

The total fuel calculations for the example flight plan are shown below.

(1) Total Fuel Required	
(c)(5) plus (d)(3) plus (e)(7), (.4 gal. plus .15 gal. plus 16.1 gal.)	16.65 gal.
(16.65 gal. multiplied by 6 lb/gal.)	99.9 lbs.

*reference Figure 5-21

THIS PAGE INTENTIONALLY LEFT BLANK

5.7 PERFORMANCE GRAPHS

LIST OF FIGURES

Figure No.		Page No.
5-1	Temperature Conversion.....	5-10a
5-1a	Airspeed Calibration.....	5-10b
5-2	Stall Speed Vs. Angle of Bank (Outboard Flow Strips Installed).....	5-11
5-3	Stall Speed Vs. Angle of Bank (Outboard and Inboard Flow Strips Installed).....	5-12
5-5	Takeoff Performance - Zero Degrees Wing Flaps	5-13
5-7	Takeoff Performance Over 50 Ft. Barrier - Zero Degrees Wing Flaps	5-14
5-9	Takeoff Performance - One Notch Wing Flaps	5-15
5-11	Takeoff Performance Over 50 Ft. Barrier - One Notch Wing Flaps	5-16
5-13	Climb Performance.....	5-17
5-15	Fuel, Time and Distance to Climb	5-18
5-17	Engine Performance.....	5-19
5-19	Speed Power - Best Power Mixture Below 75%	5-20
5-21	Speed Power - Best Economy Mixture.....	5-21
5-23	Best Power Range.....	5-22
5-25	Best Economy Range.....	5-23
5-27	Best Power Endurance	5-24
5-29	Best Economy Endurance.....	5-25
5-31	Fuel, Time and Distance to Descend	5-26
5-33	Glide Performance	5-27
5-35	Landing Ground Roll (Outboard Flow Strips Installed)	5-28
5-36	Landing Ground Roll (Outboard and Inboard Flow Strips Installed).....	5-28a
5-37	Landing Distance Over 50 Ft. Barrier (Outboard Flow Strips Installed)	5-28b
5-38	Landing Distance Over 50 Ft. Barrier (Outboard and Inboard Flow Strips Installed)	5-29

THIS PAGE INTENTIONALLY LEFT BLANK

PA-38-112

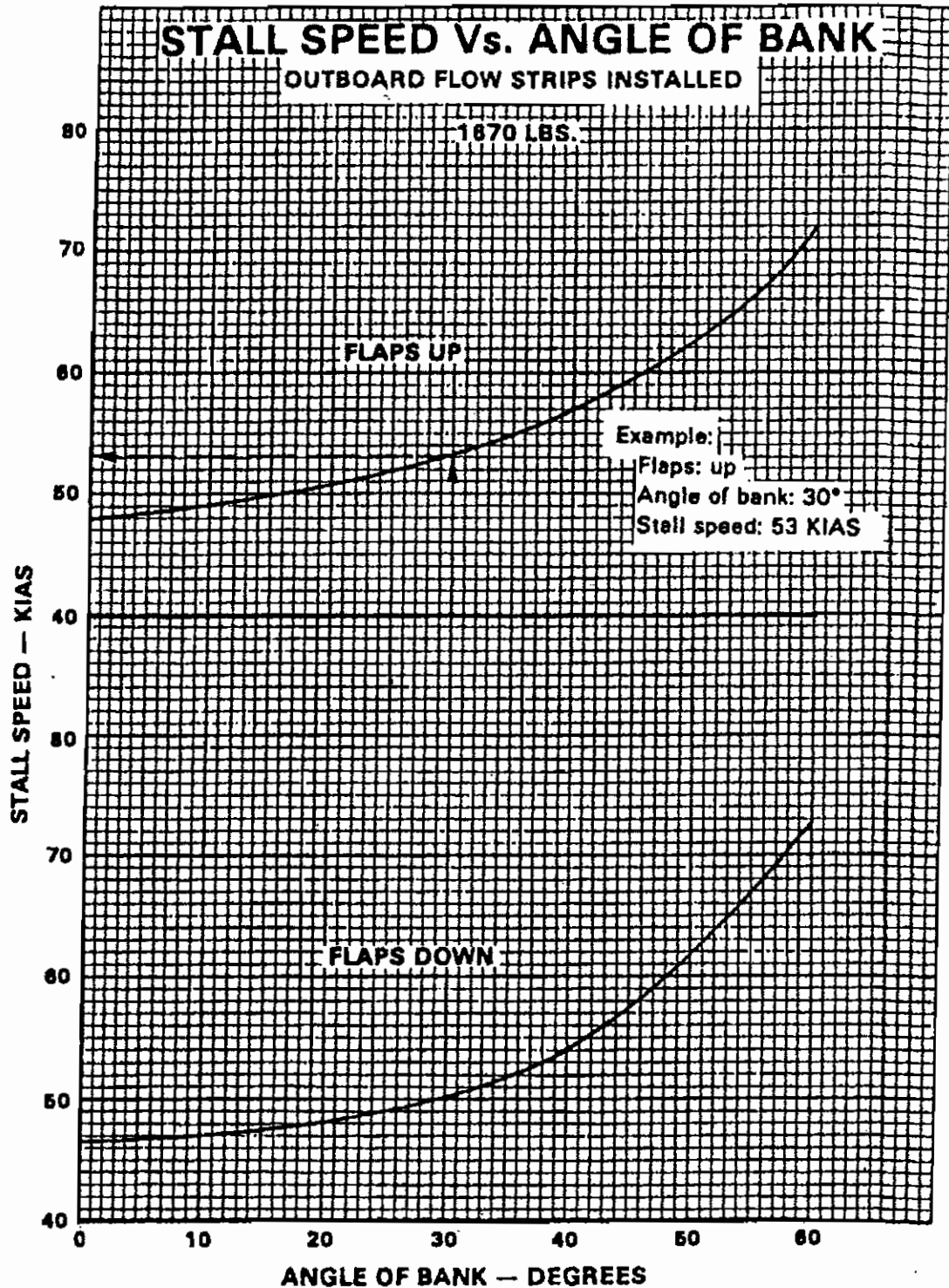

STALL SPEED VS. ANGLE OF BANK
(OUTBOARD FLOW STRIPS INSTALLED)

Figure 5-2

PA-38-112

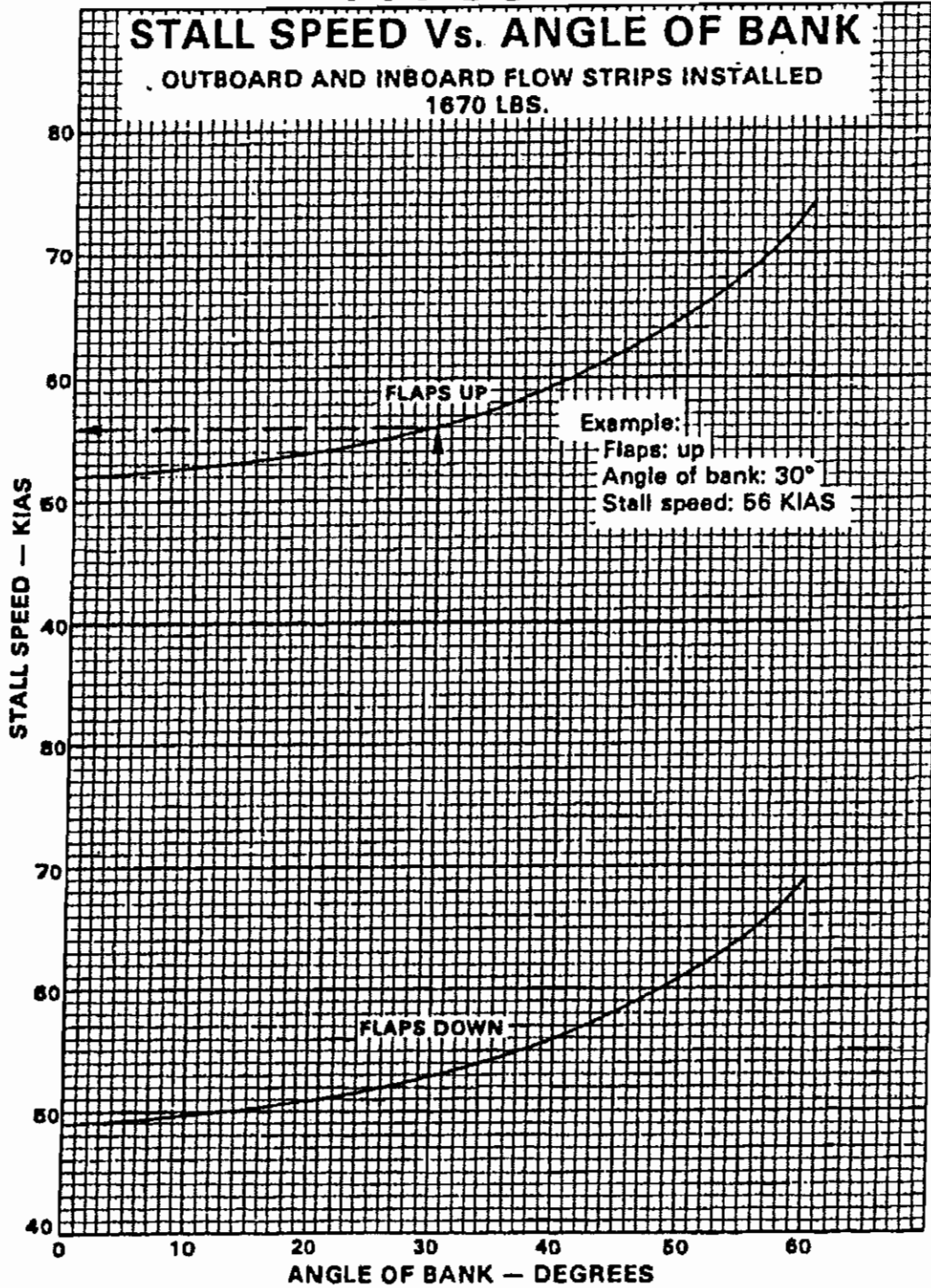

STALL SPEED VS. ANGLE OF BANK
(OUTBOARD AND INBOARD FLOW STRIPS INSTALLED)

Figure 5-3

PA-38-112

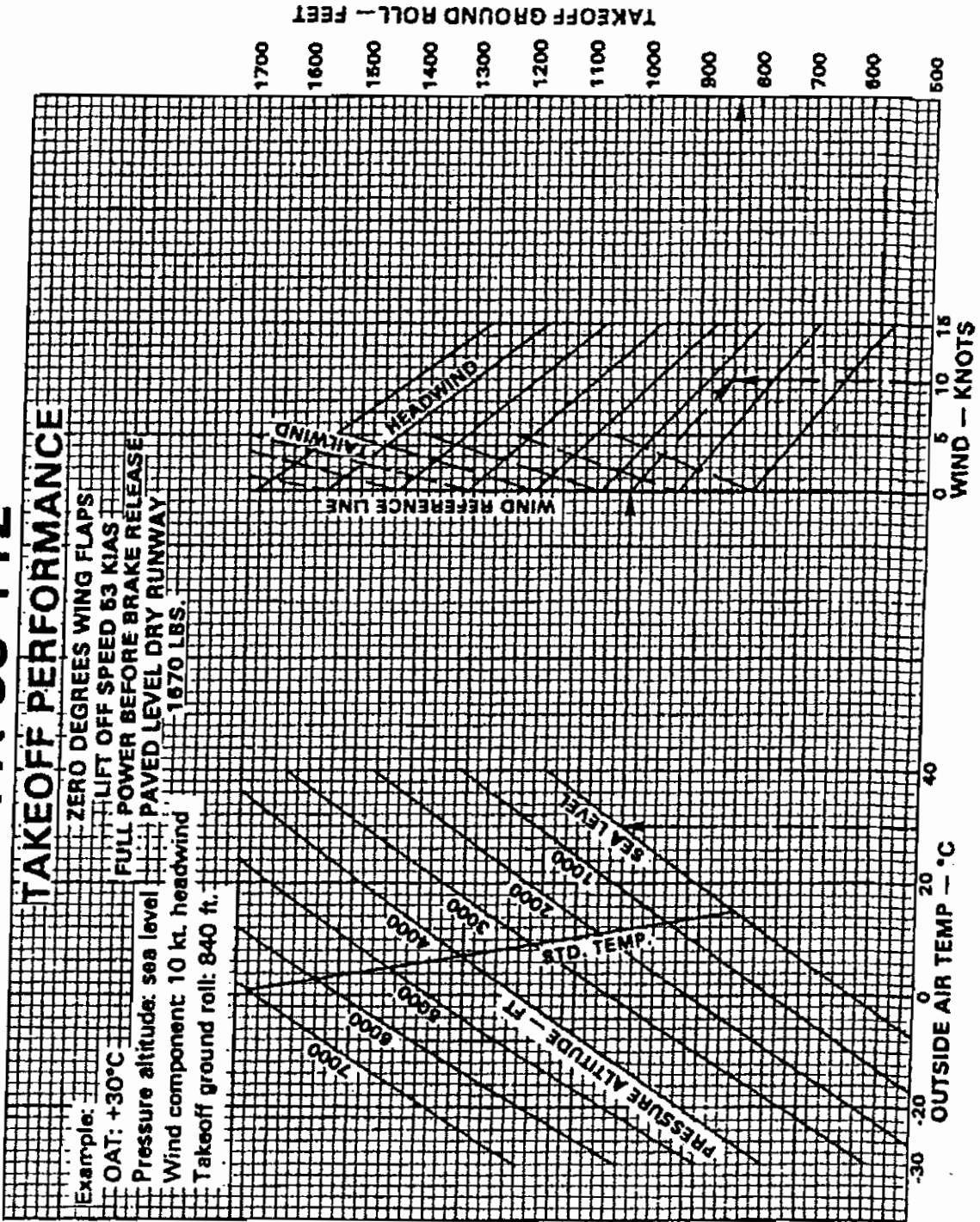

TAKEOFF PERFORMANCE - ZERO DEGREES WING FLAPS
Figure 5-5

PA-38-112

TAKEOFF PERFORMANCE OVER 50' BARRIER

ZERO DEGREES WING FLAPS
LIFT OFF SPEED 63 KIAS
BARRIER SPEED 62 KIAS
FULL POWER BEFORE BRAKE RELEASE
PAVED LEVEL DRY RUNWAY
1670 LBS.

Example:

OAT: +8°C

Pressure altitude: 1100 ft.

Wind component: 10 kt. headwind

Takeoff distance: 1320 ft.

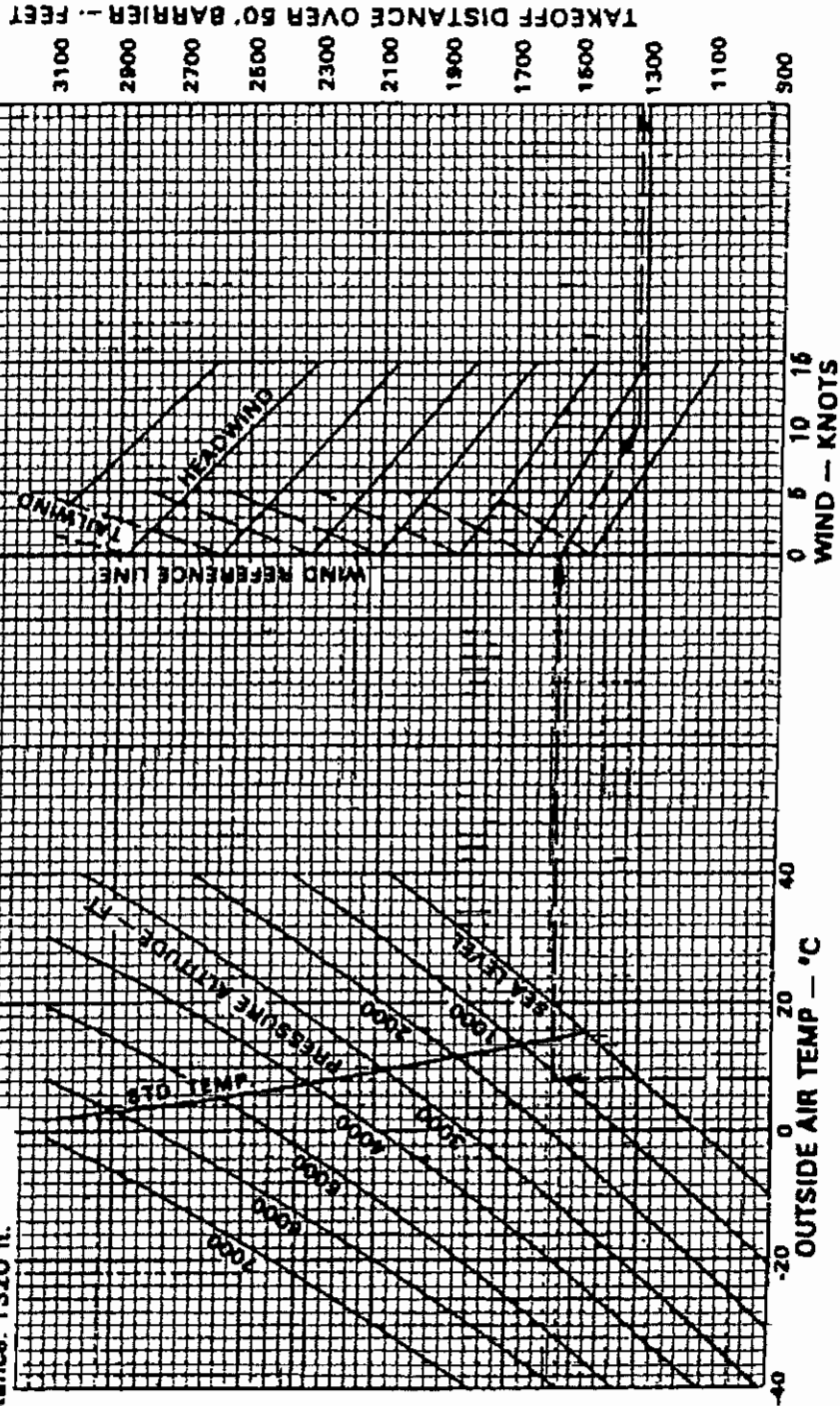

TAKEOFF PERFORMANCE OVER 50 FT. BARRIER -
ZERO DEGREES WING FLAPS

Figure 5-7

PA-38-112

TAKEOFF PERFORMANCE

ONE NOTCH WING FLAPS
 LIFT OFF SPEED 53 KIAS
 FULL POWER BEFORE BRAKE RELEASE
 PAVED LEVEL DRY RUNWAY
 1670 LBS.

Example:

OAT: +30°C

Pressure altitude: sea level

Wind component: 10 kt. headwind

Takeoff ground roll: 810 ft.

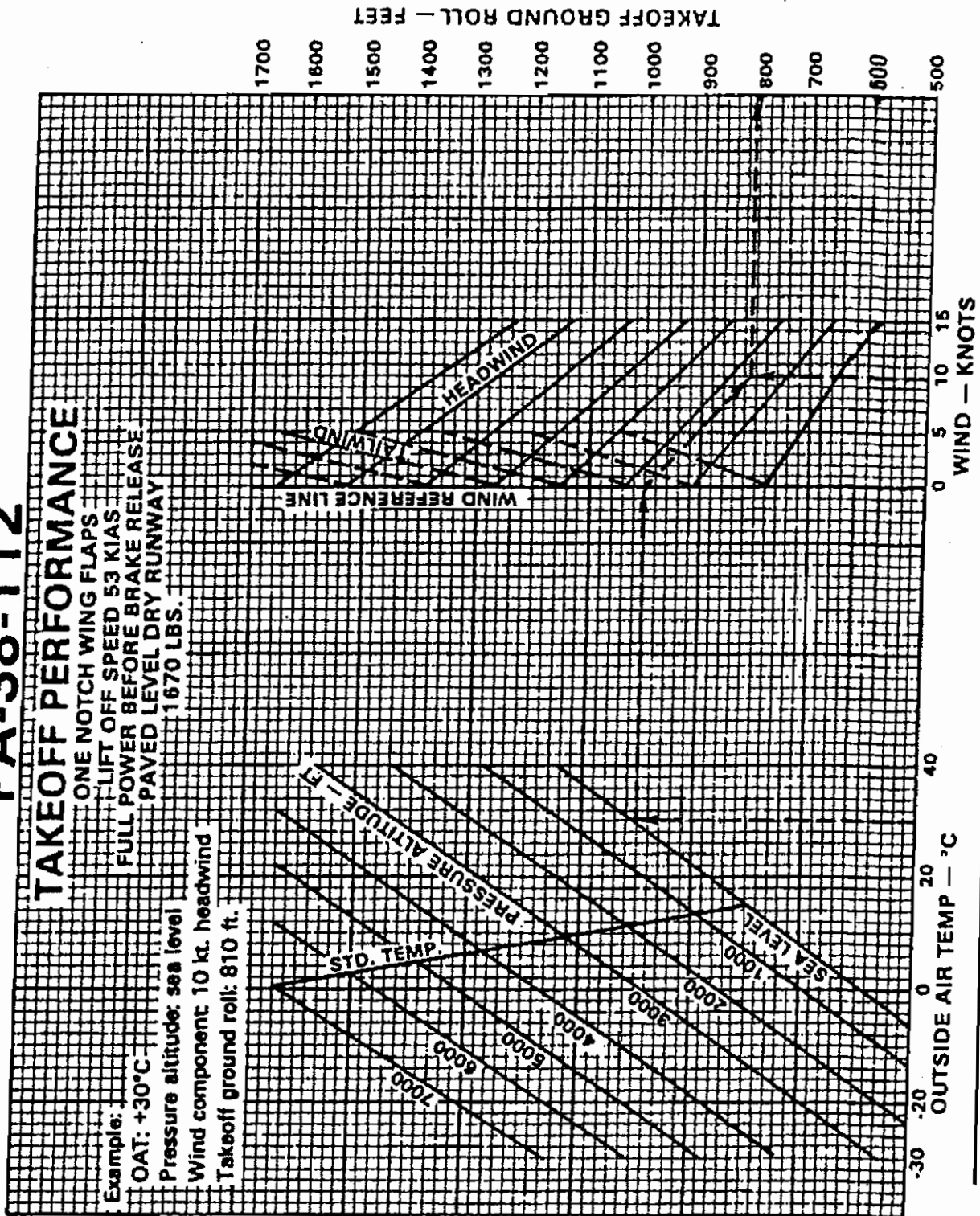

TAKEOFF PERFORMANCE - ONE NOTCH WING FLAPS
 Figure 5-9

PA-38-112

TAKEOFF PERFORMANCE OVER 50' BARRIER

4746CA

Example:
 ONE NOTCH WING FLAPS
 LIFT OFF SPEED 53 KIAS
 BARRIER SPEED 62 KIAS
 OAT: +30°C
 FULL POWER BEFORE BRAKE RELEASE
 Pressure altitude: sea level
 PAVED LEVEL DRY RUNWAY
 Wind component: 10 kt. headwind
 1670 LBS
 Takeoff distance: 1380 ft.

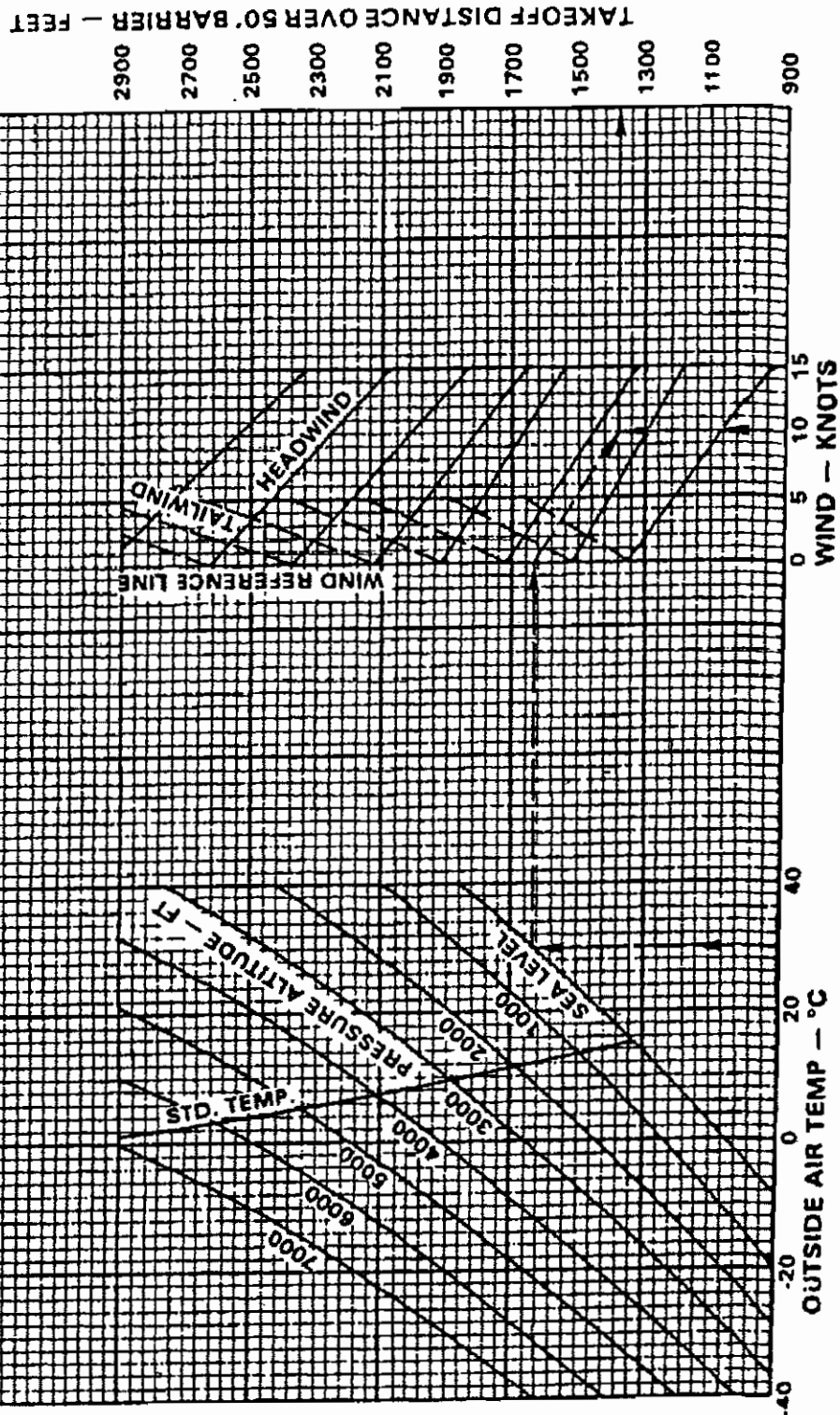

TAKEOFF PERFORMANCE OVER 50 FT. BARRIER -
ONE NOTCH WING FLAPS

Figure 5-11

PA-38-112

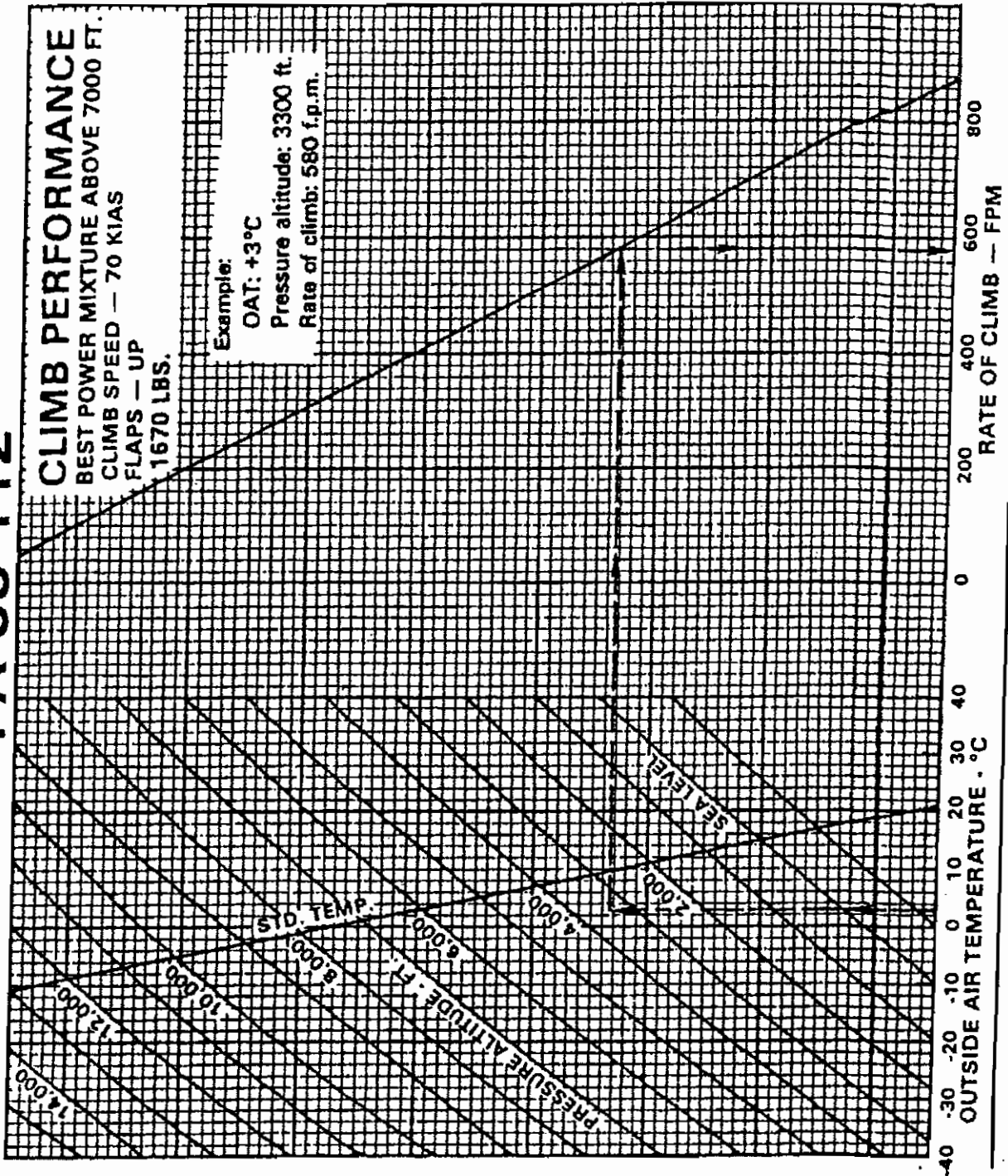

CLIMB PERFORMANCE

Figure 5-13

PA-38-112

FUEL, TIME & DISTANCE TO CLIMB

CLIMB SPEED - 70 KIAS, FLAPS UP
FULL THROTTLE
BEST POWER MIXTURE
ABOVE 7000 FT.
1670 LBS.

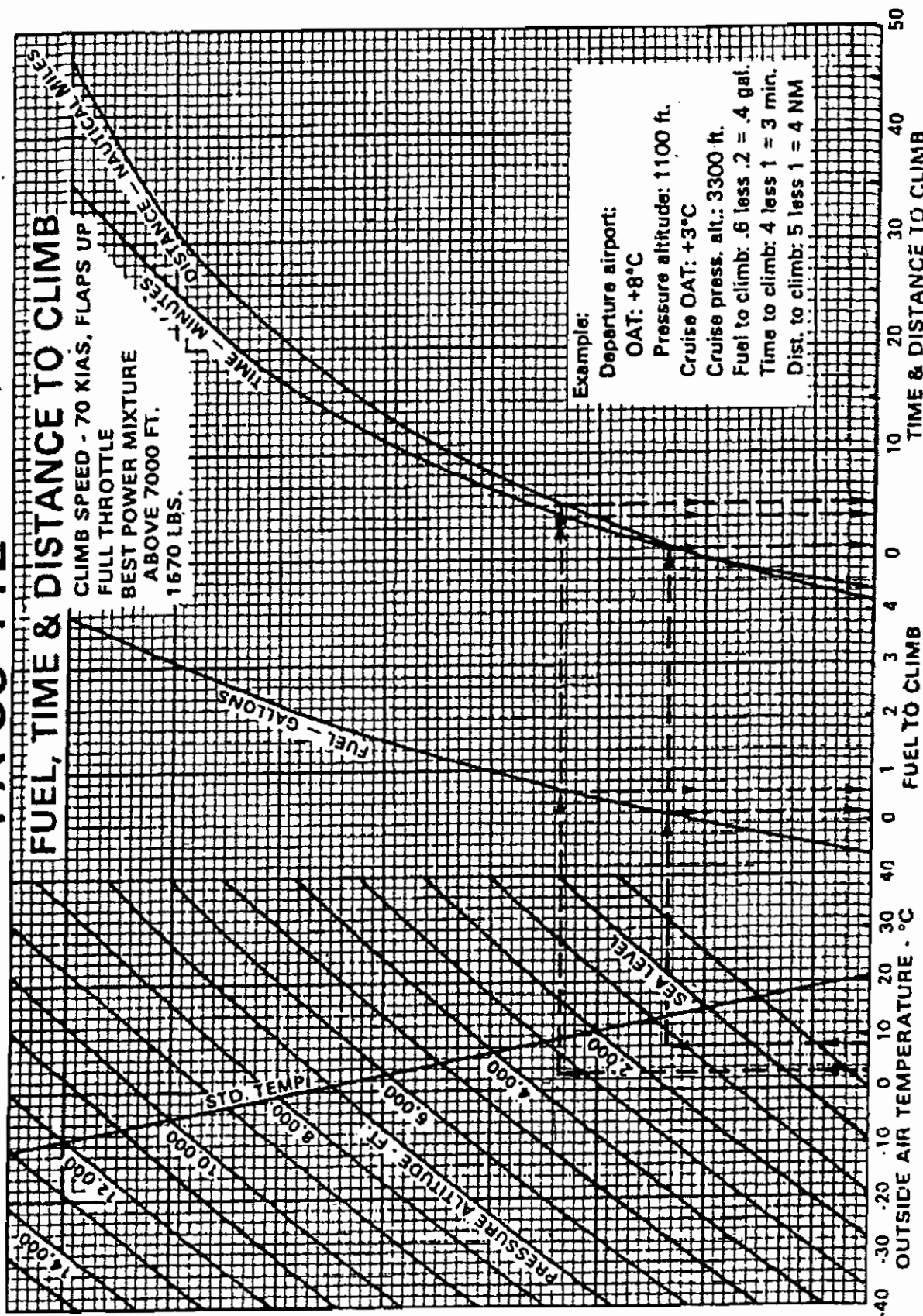

Example:
Departure airport:
OAT: +8°C
Pressure altitude: 1100 ft.
Cruise OAT: +3°C
Cruise press. alt.: 3300 ft.
Fuel to climb: .6 less .2 = .4 gal.
Time to climb: 4 less 1 = 3 min.
Dist. to climb: 5 less 1 = 4 NM

FUEL, TIME AND DISTANCE TO CLIMB
Figure 5-15

PA-38-112

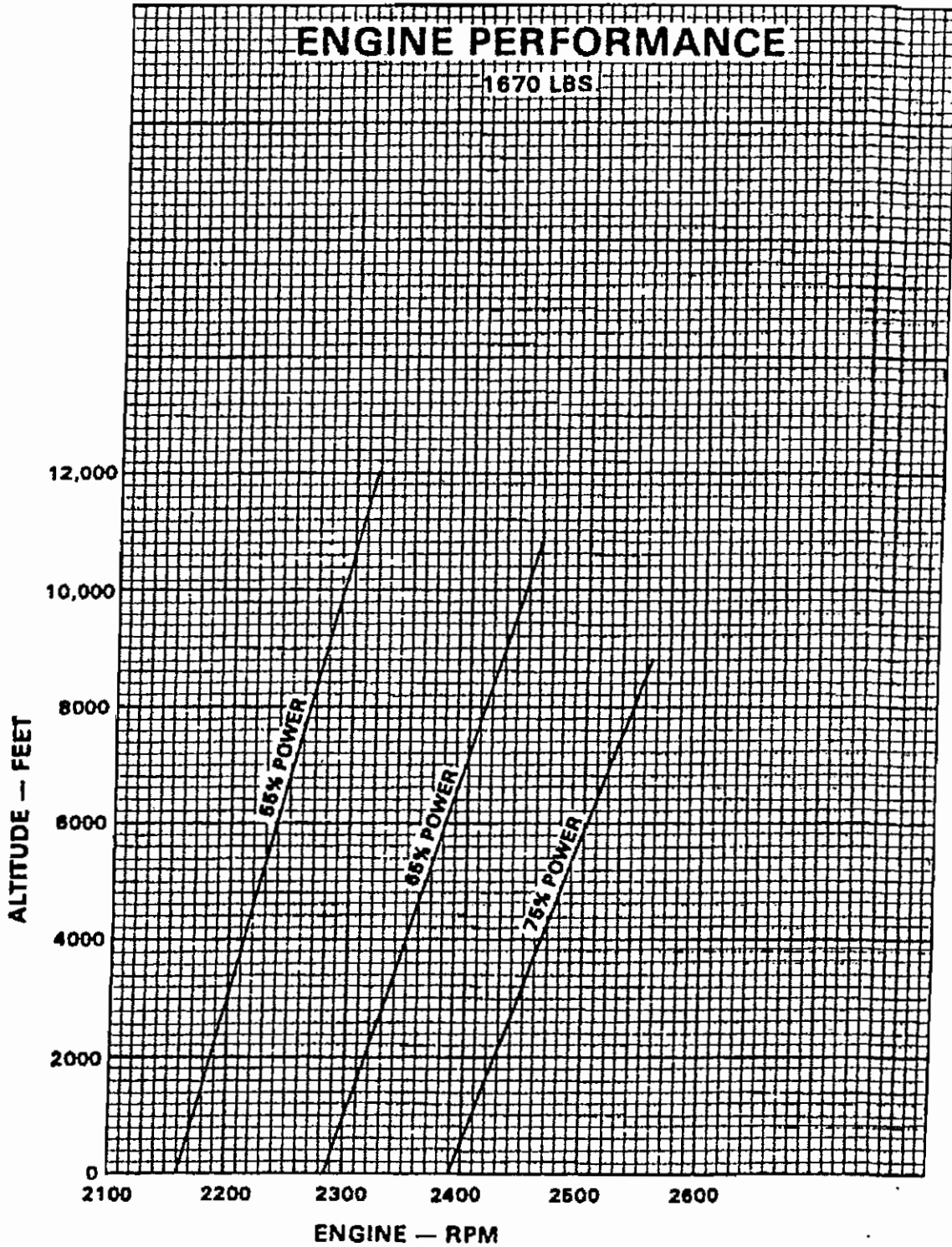

ENGINE PERFORMANCE
Figure 5-17

PA-38-112

SPEED POWER

BEST POWER MIXTURE
BELOW 75% POWER
1670 LBS.

% PWR.	FUEL FLOW
75%	6.5 GPH
65%	5.76 GPH
55%	5.0 GPH

Example:
Cruise OAT: +3°C
Cruise press. alt.: 3300 ft.
Cruise power: 65%
Cruise speed: 93 kts.

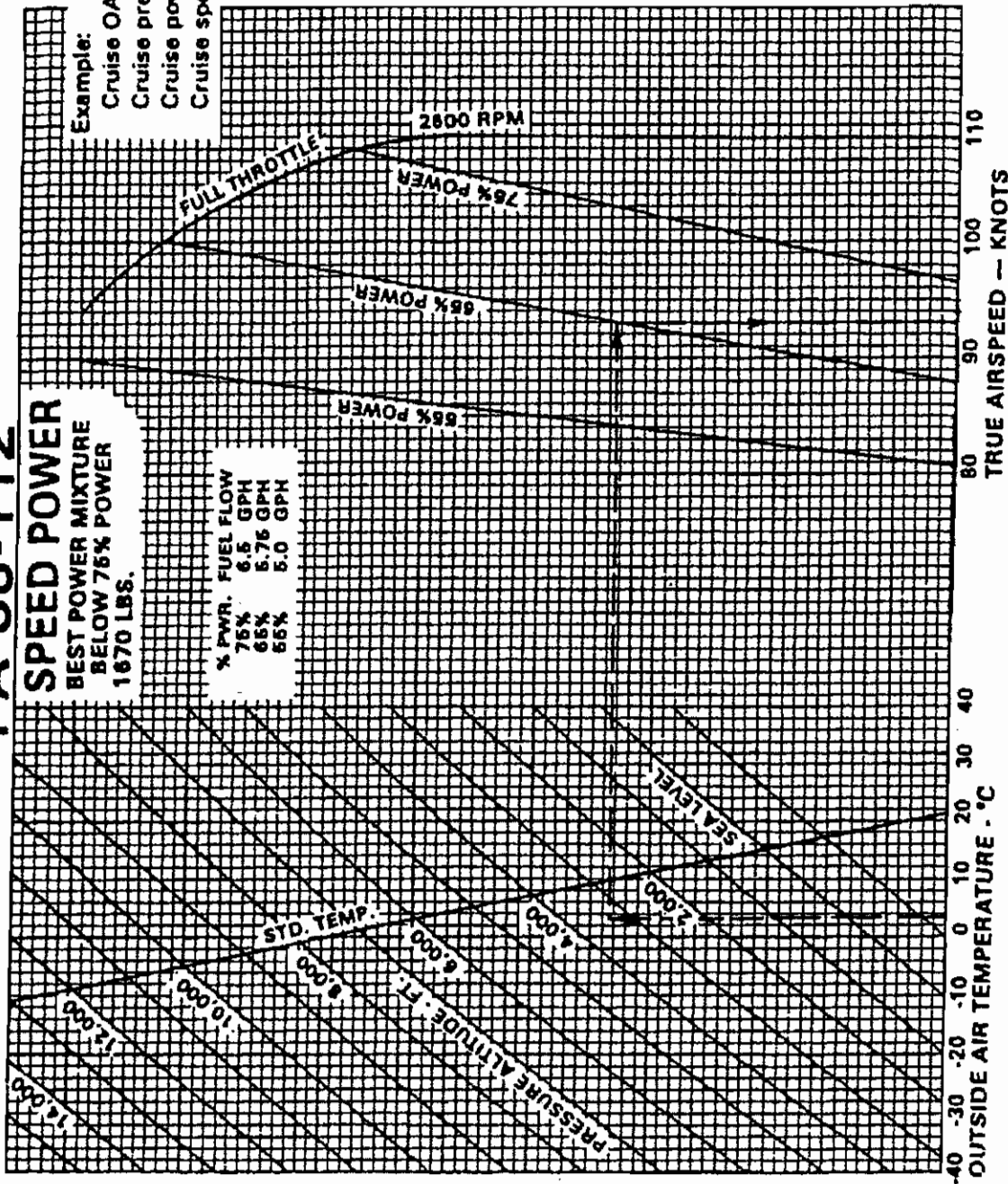

SPEED POWER - BEST POWER MIXTURE BELOW 75%

Figure 5-19

PA-38-112

SPEED POWER
BEST ECONOMY MIXTURE
1670 LBS.

% POWER FUEL FLOW	
75%	5.6 GPH
65%	4.9 GPH
55%	4.3 GPH

Example:
Cruise OAT: +3°C
Cruise press. alt.: 3300 ft.
Cruise power: 65%
Cruise speed: 88.5 kts.

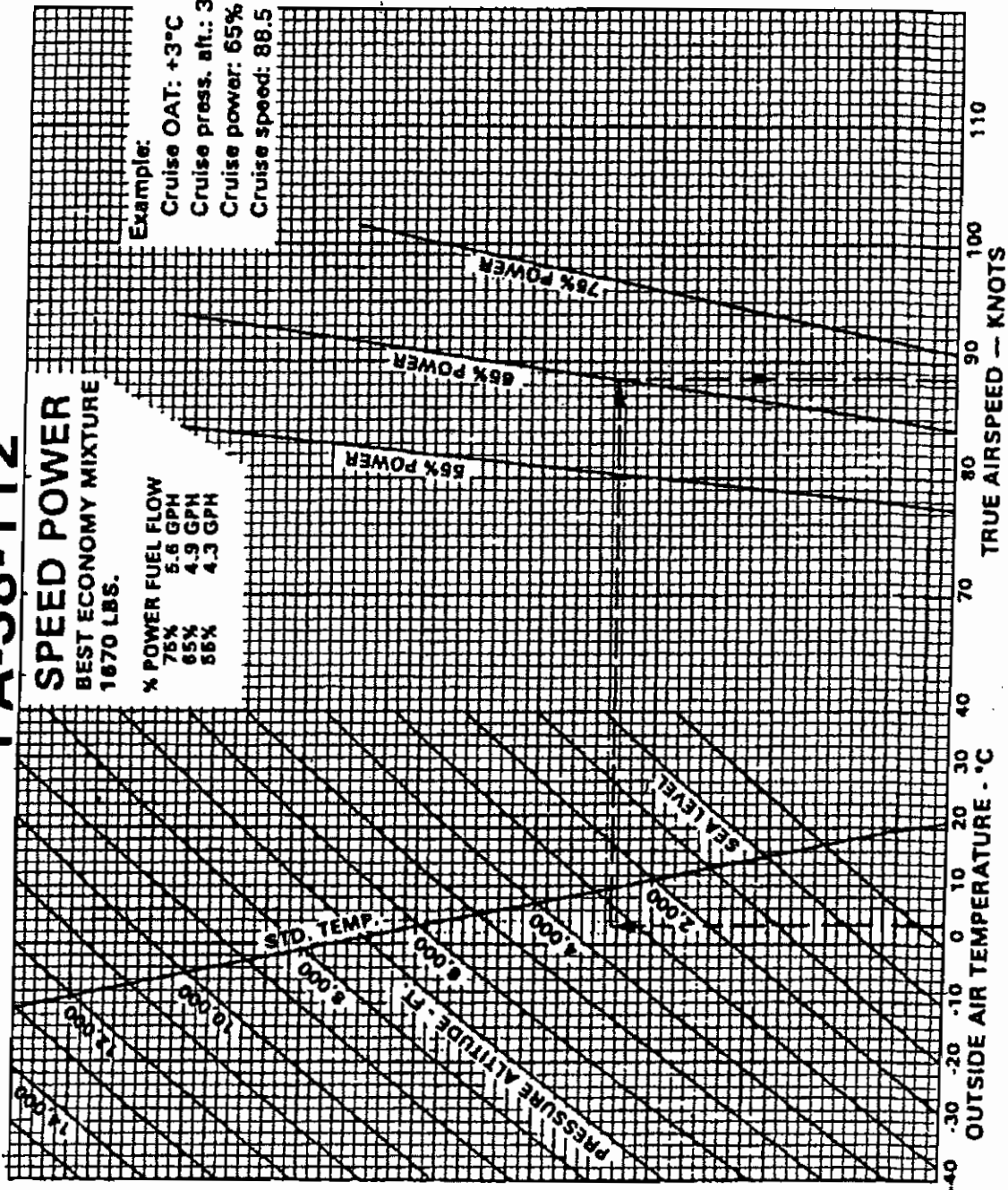

SPEED POWER - BEST ECONOMY MIXTURE
Figure 5-21

PA-38-112

BEST POWER RANGE

MIXTURE — LEAN PER LYCOMING INSTRUCTION

NO WIND 1670 LBS.
RANGE INCLUDES CLIMB & DESCENT DISTANCES
ALLOWANCE MADE FOR START, TAXI, TAKEOFF, CLIMB AND DESCENT FUEL.
USABLE FUEL — 30 GAL.

RANGE WITH 45 MIN. RES. AT 65% PWR.

Example:

Cruise OAT: +3°C

Cruise press. alt.: 3300 ft.

Cruise power: 65%

Range with reserve: 410 NM

Range no reserve: 470 NM

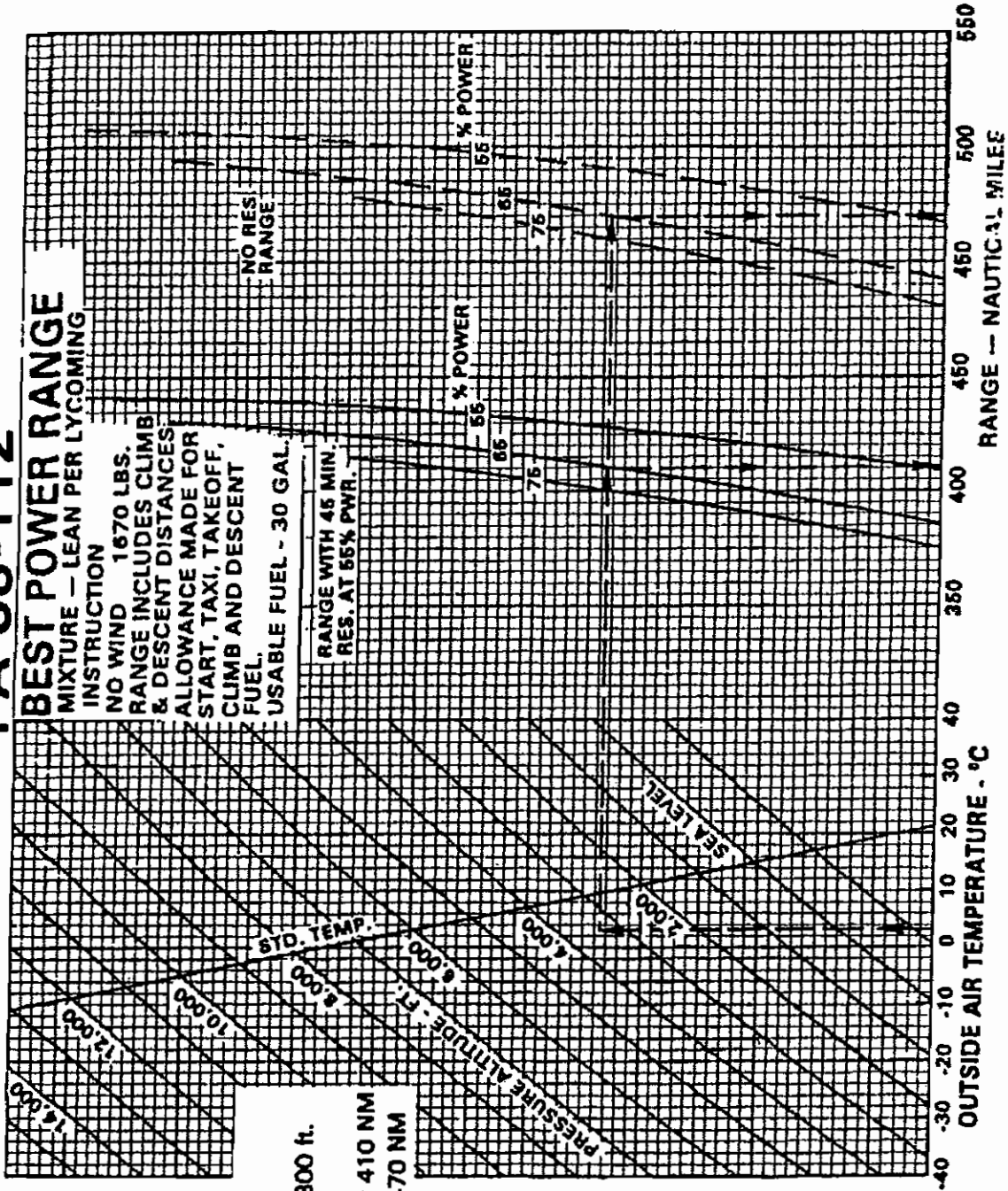

BEST POWER RANGE

Figure 5-23

PA-38-112

BEST ECONOMY RANGE

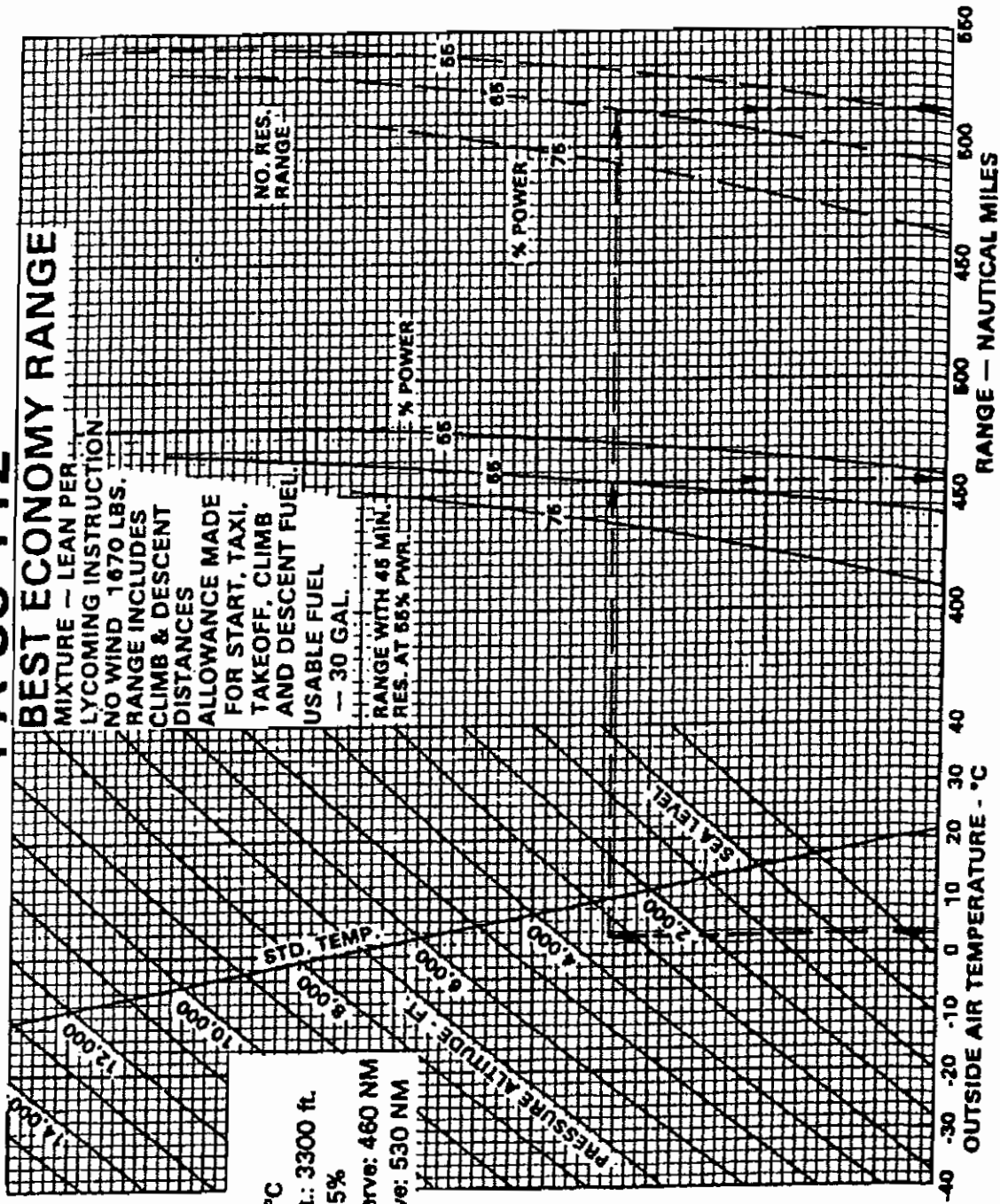

Example:

- Cruise OAT: +3°C
- Cruise press. alt.: 3300 ft.
- Cruise power: 65%
- Range with reserve: 460 NM
- Range no reserve: 530 NM

BEST ECONOMY RANGE

Figure 5-25

PA-38-112

BEST POWER ENDURANCE

MIXTURE — LEAN PER LYCOMING INSTRUCTION
ALLOWANCE MADE
FOR START, TAXI,
TAKEOFF, CLIMB
AND DESCENT FUEL
USABLE FUEL
— 30 GAL.
1670 LBS.

ENDURANCE
WITH NO RES.

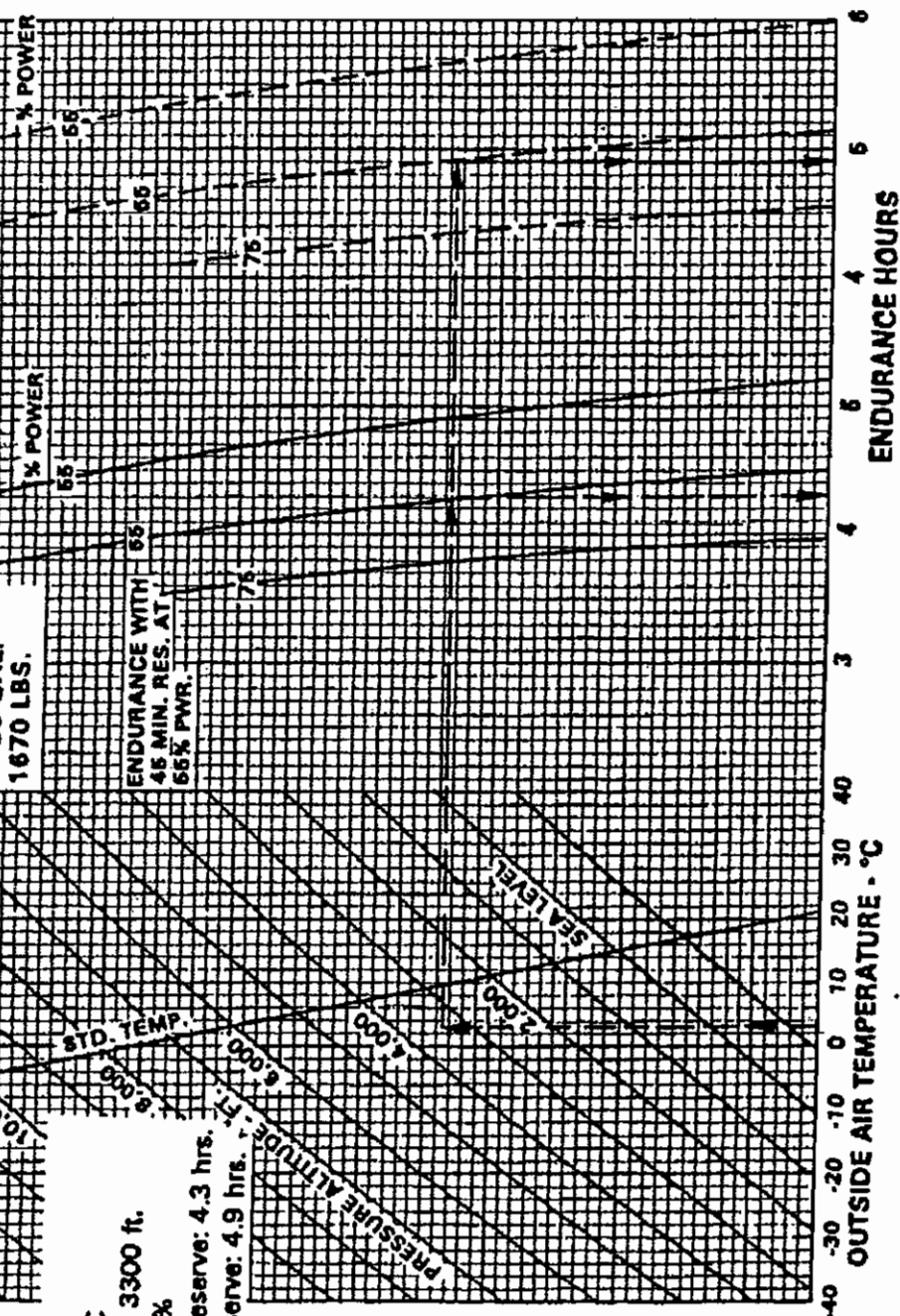

Example:
Cruise OAT: +3°C
Cruise press. alt.: 3300 ft.
Cruise power: 65%
Endurance with reserve: 4.3 hrs.
Endurance no reserve: 4.9 hrs.

BEST POWER ENDURANCE

Figure 5-27

PA-38-112

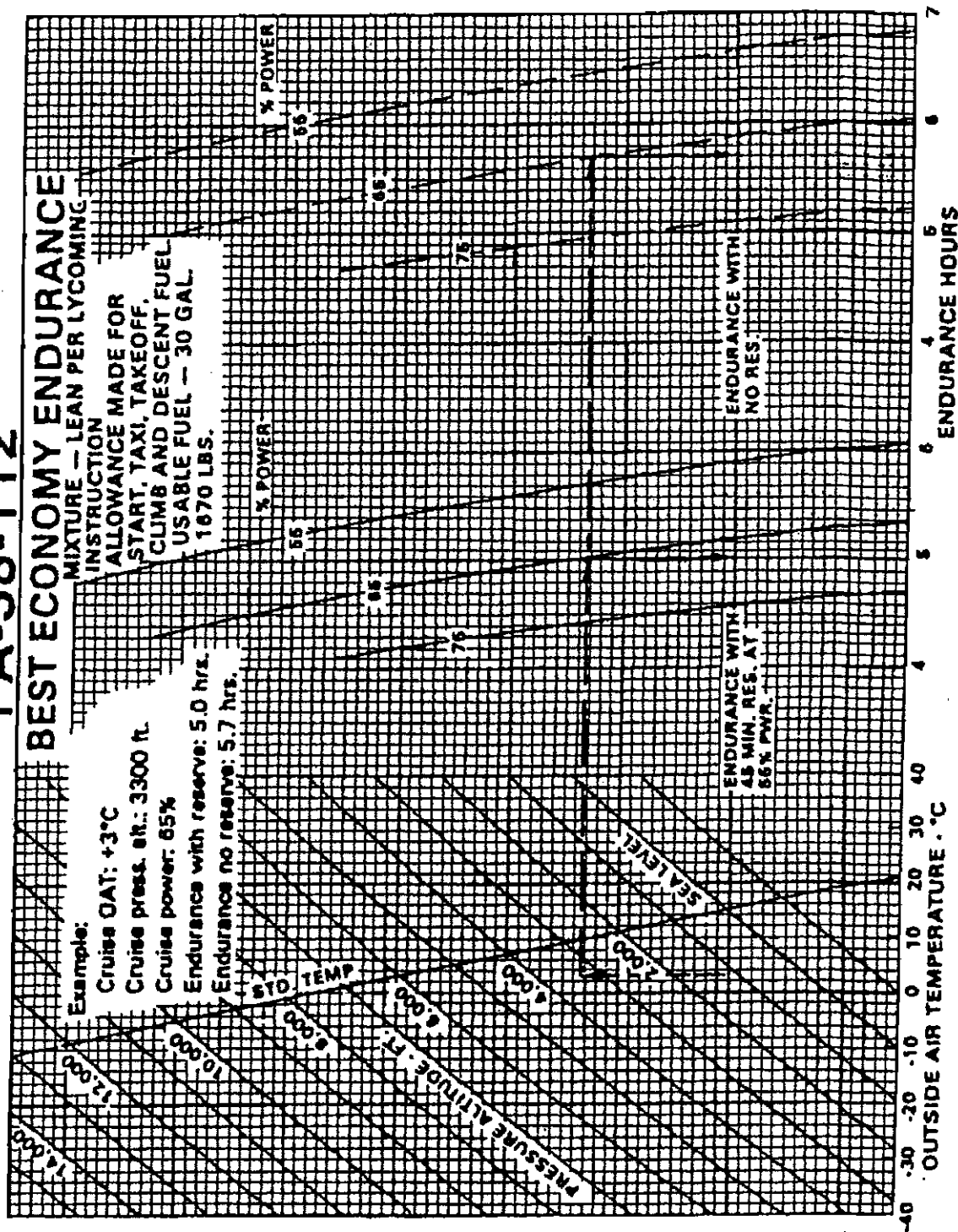

BEST ECONOMY ENDURANCE
Figure 5-29

PA-38-112

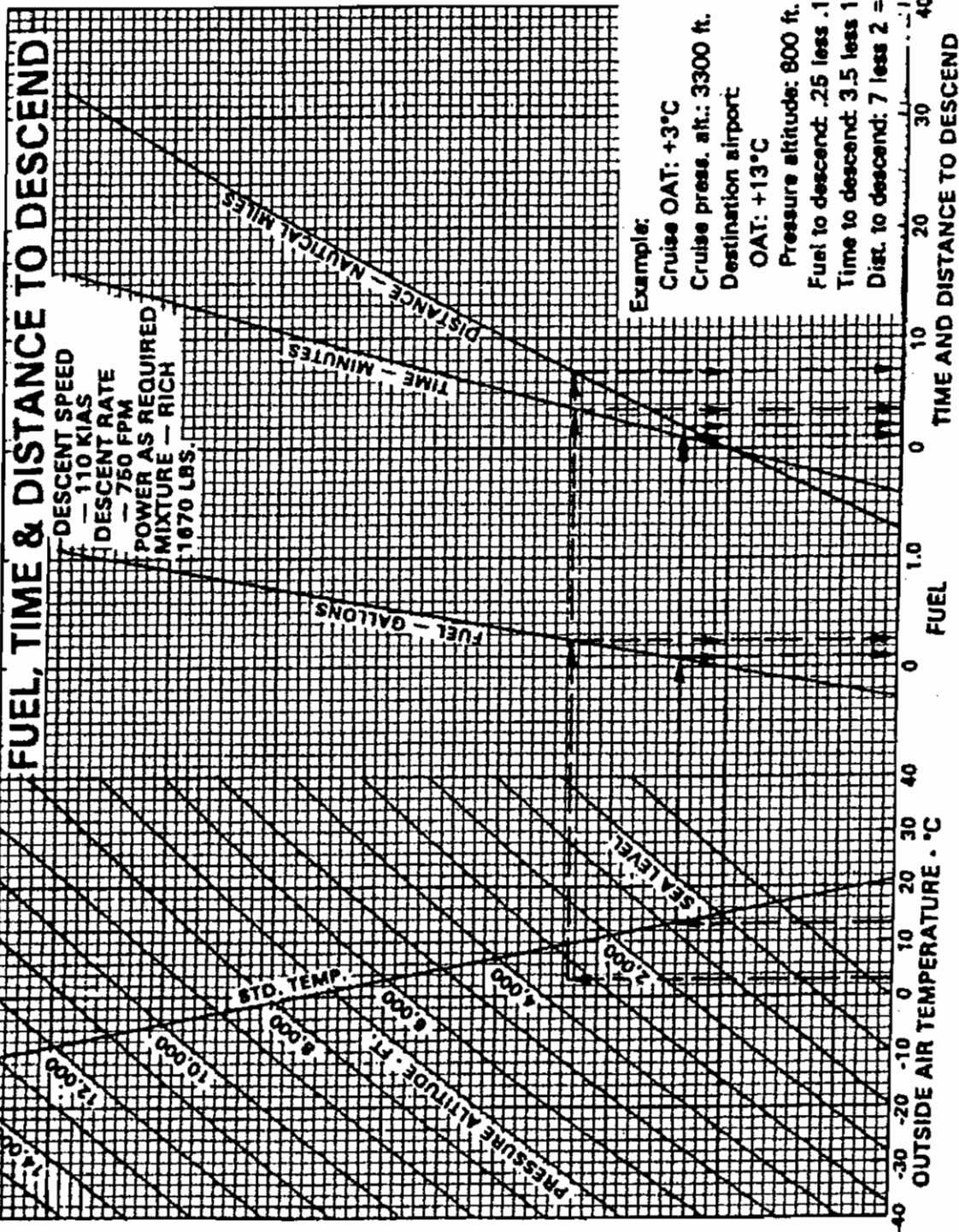

FUEL, TIME AND DISTANCE TO DESCEND

Figure 5-31

PA-38-112

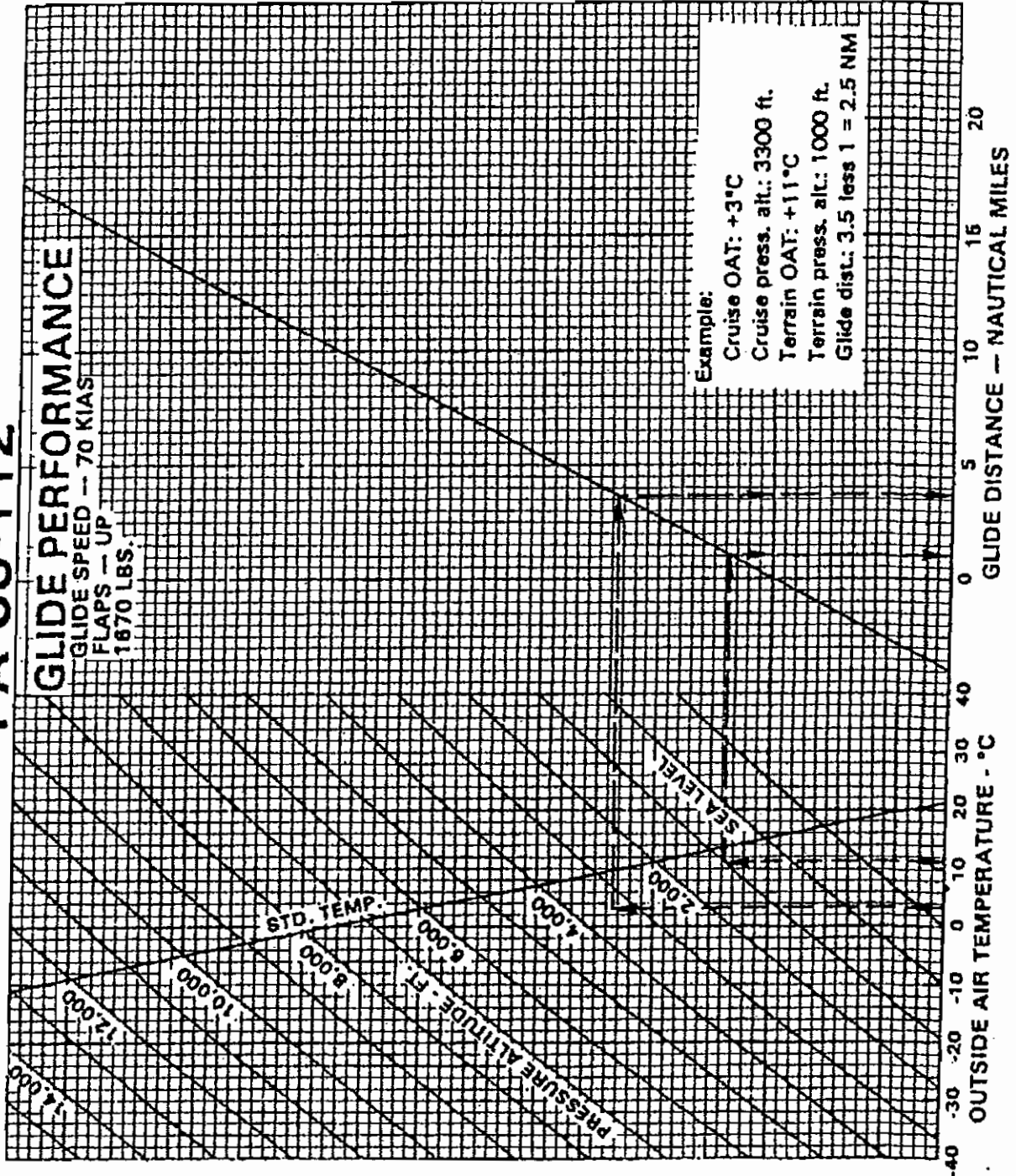

GLIDE PERFORMANCE
 Figure 5-33

PA-38-112

LANDING GROUND ROLL

- OUTBOARD FLOW STRIPS INSTALLED
- WING FLAPS — SECOND NOTCH
- POWER OFF APPROACH AT 62 KIAS
- FULL STALL TOUCHDOWN
- MAXIMUM BRAKING
- PAVED LEVEL DRY RUNWAY
- 1670 LBS.

Example:

- OAT: +13°C
- Pressure altitude: 800 ft.
- Wind component: 2 kt. tailwind
- Landing ground roll: 720 ft.

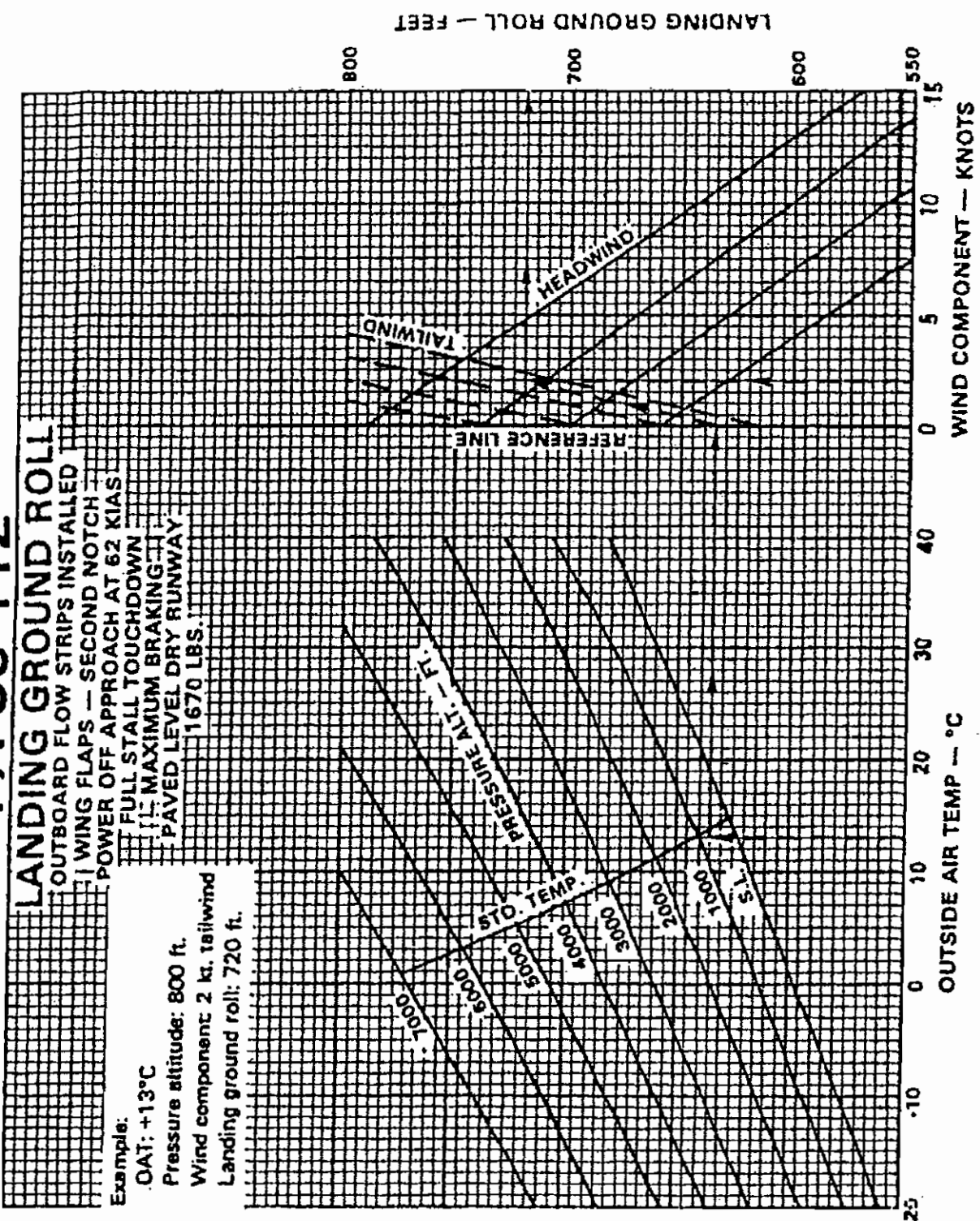

LANDING GROUND ROLL
(OUTBOARD FLOW STRIPS INSTALLED)
Figure 5-35

PA-38-112

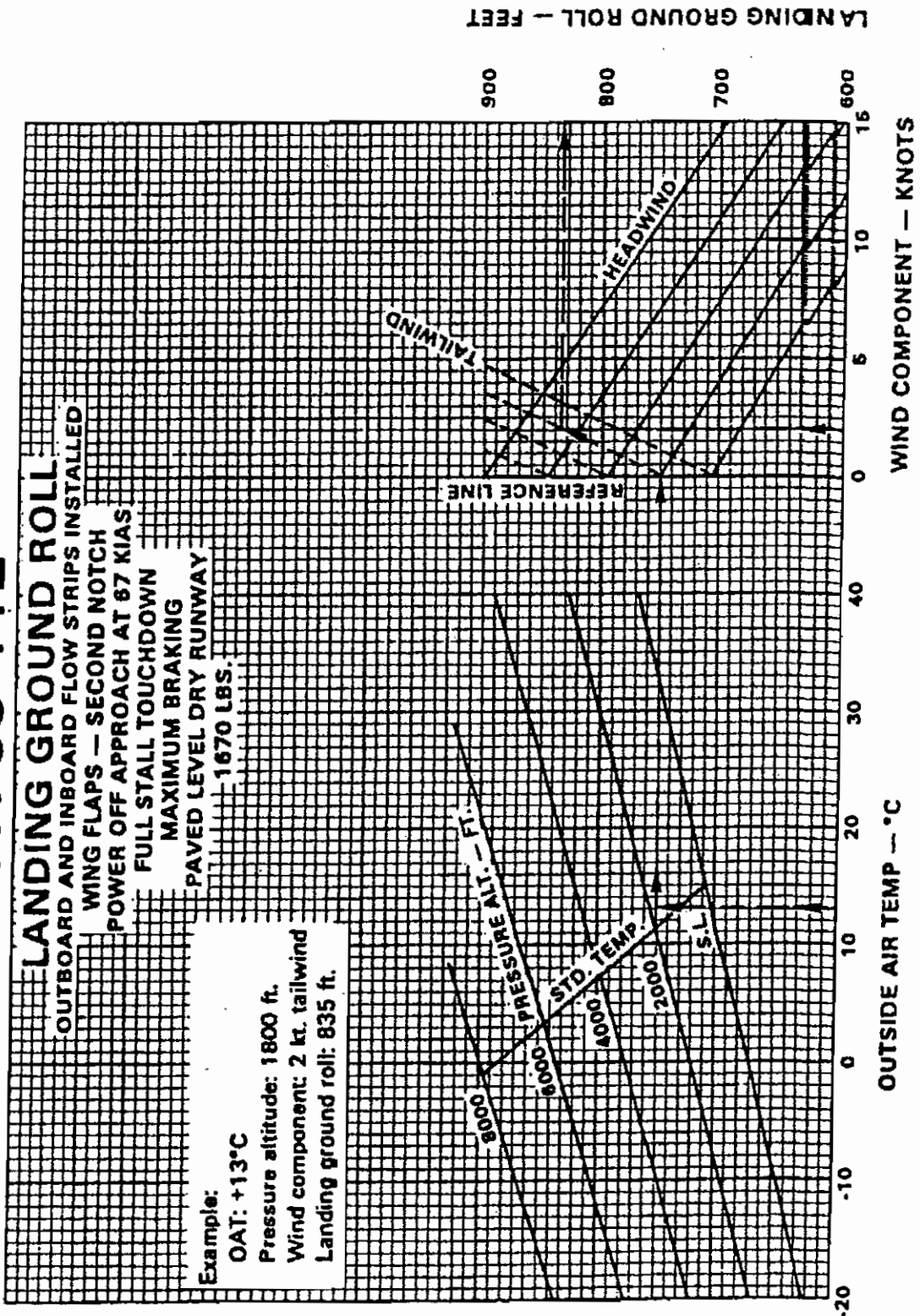

**LANDING GROUND ROLL
(OUTBOARD AND INBOARD FLOW STRIPS INSTALLED)**

Figure 5-36

PA-38-112

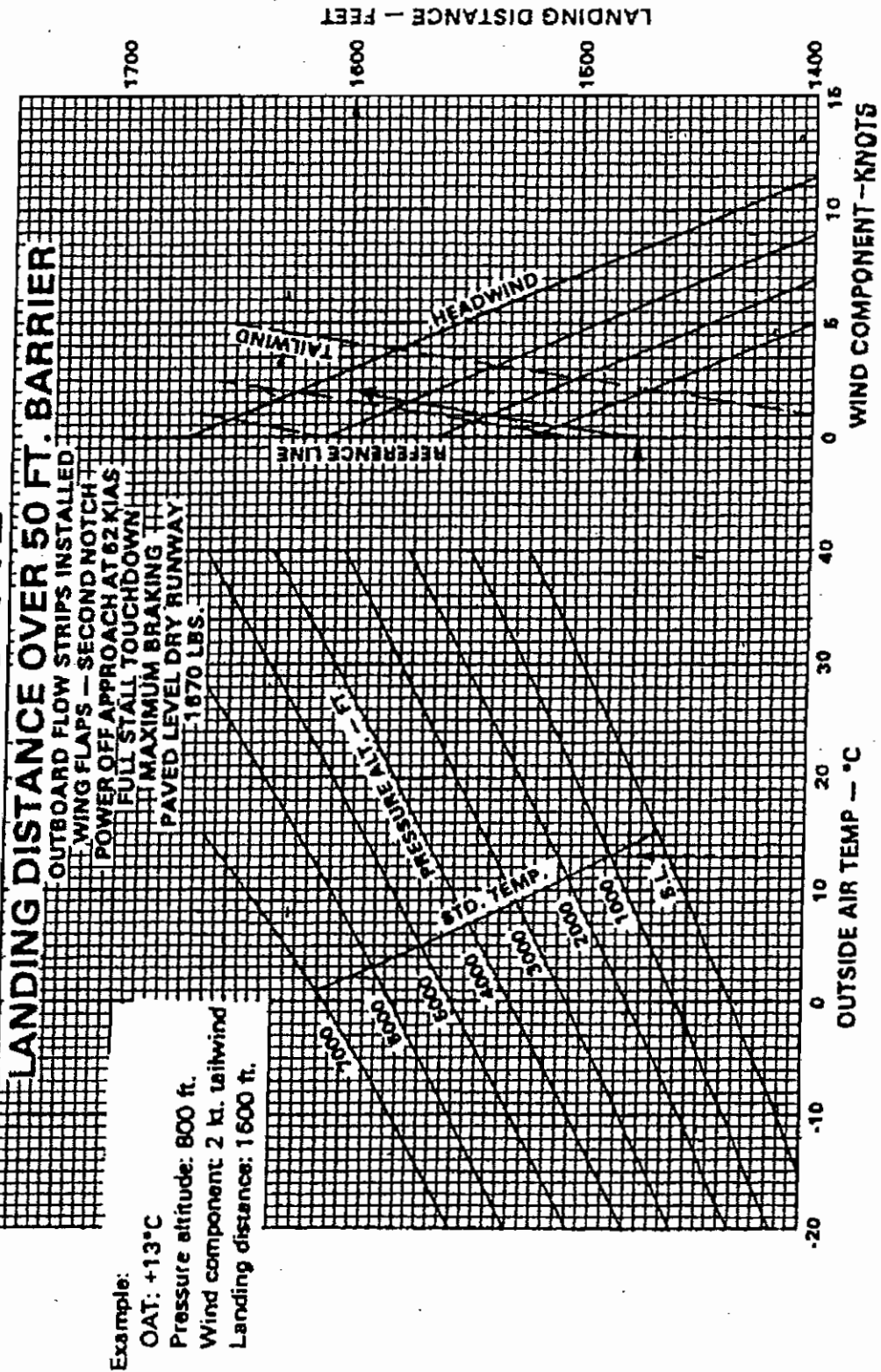

**LANDING DISTANCE OVER 50 FT. BARRIER
 (OUTBOARD FLOW STRIPS INSTALLED)**

Figure 5-37

PA-38-112

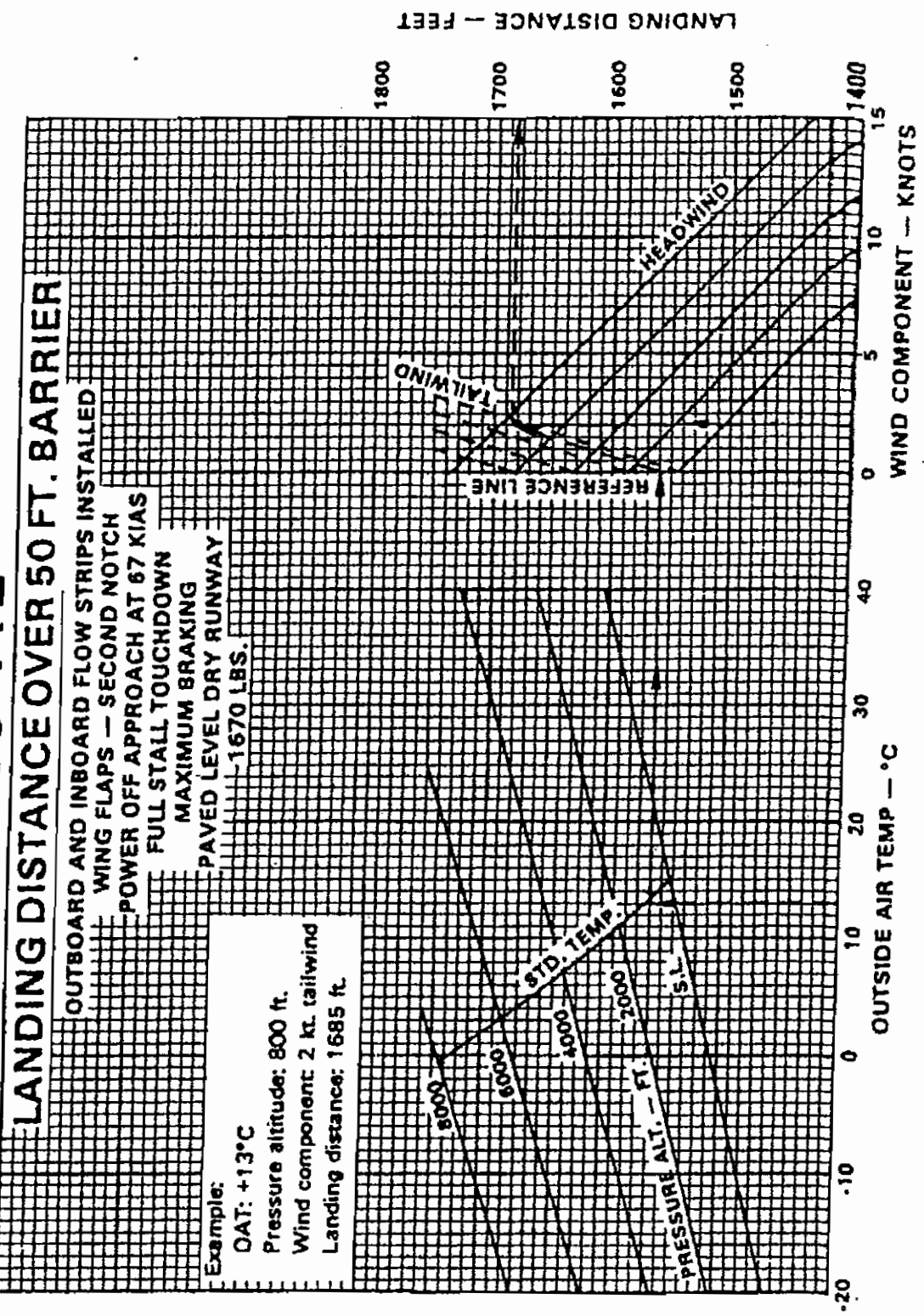

**LANDING DISTANCE OVER 50 FT. BARRIER
 (OUTBOARD AND INBOARD FLOW STRIPS INSTALLED)**
 Figure 5-38

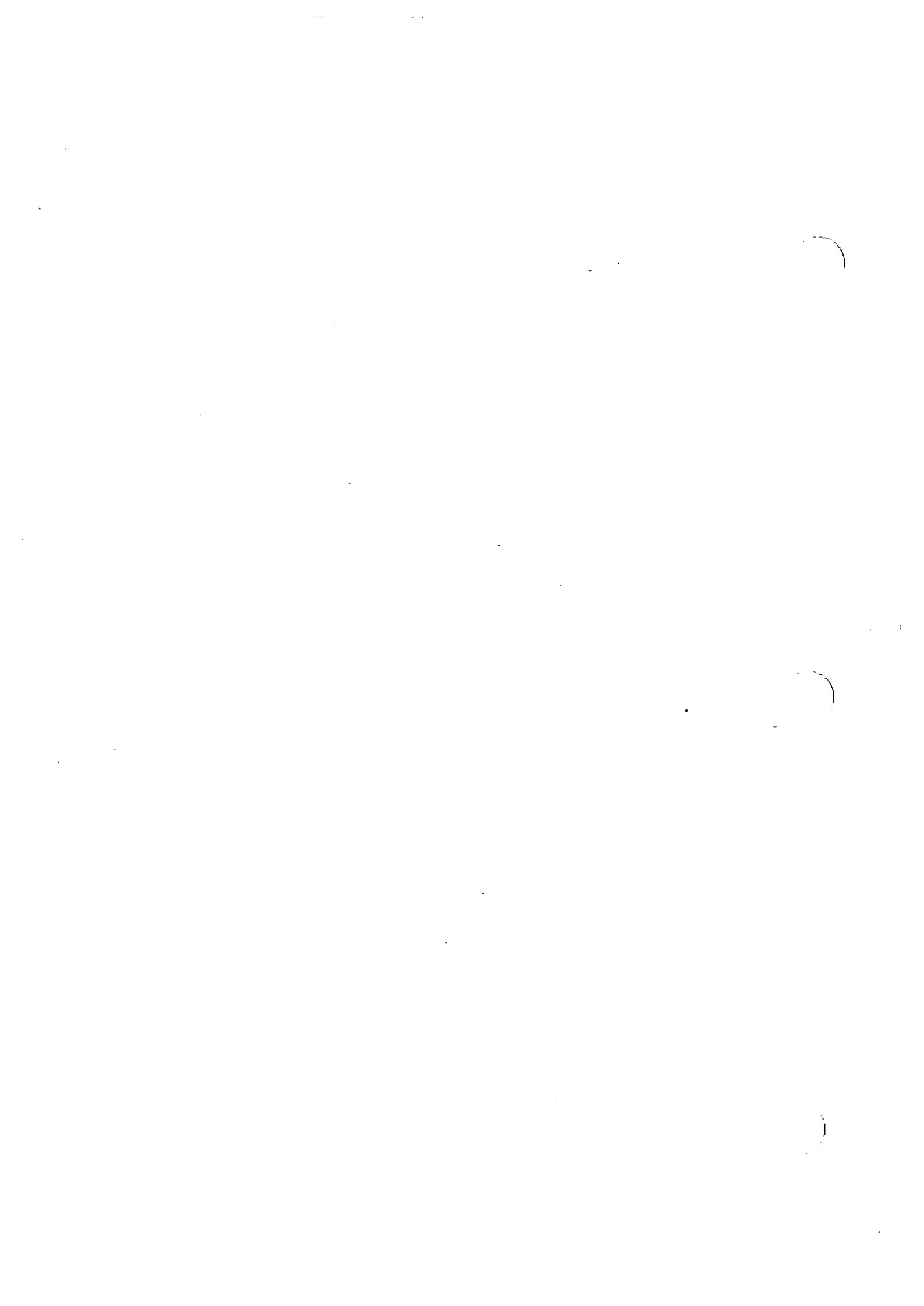
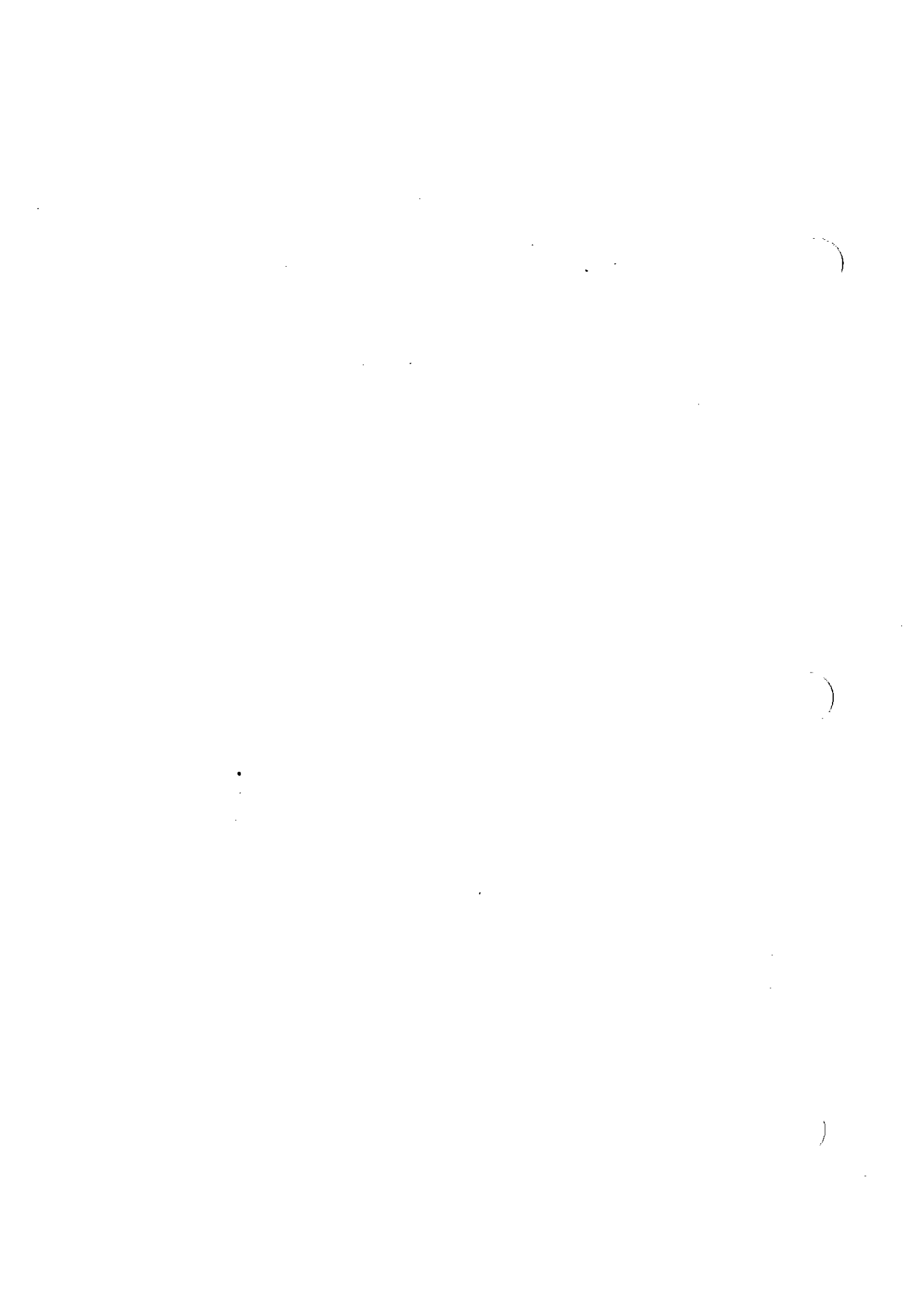

TABLE OF CONTENTS
SECTION 6
WEIGHT AND BALANCE

Paragraph No.		Page No.
6.1	General.....	6-1
6.3	Airplane Weighing Procedure.....	6-2
6.5	Weight and Balance Data and Record	6-5
6.7	Weight and Balance Determination for Flight.....	6-9



SECTION 6

WEIGHT AND BALANCE

6.1 GENERAL

In order to achieve the performance and flying characteristics which are designed into the airplane, it must be flown with the weight and center of gravity (C.G.) position within the approved operating range (envelope). Although the airplane offers flexibility of loading, it cannot be flown with the maximum number of adult passengers, full fuel tanks and maximum baggage. With the flexibility comes responsibility. The pilot must ensure that the airplane is loaded within the loading envelope before takeoff.

Misloading carries consequences for any aircraft. An overloaded airplane will not take off, climb or cruise as well as a properly loaded one. The heavier the airplane is loaded, the less climb performance it will have.

Center of gravity is a determining factor in flight characteristics. If the C.G. is too far forward in any airplane, it may be difficult to rotate for takeoff or landing. If the C.G. is too far aft, the airplane may rotate prematurely on takeoff or tend to pitch up during climb. Longitudinal stability will be reduced. This can lead to inadvertent stalls and even spins; and spin recovery becomes more difficult as the center of gravity moves aft of the approved limit.

A properly loaded airplane, however, will perform as intended. Before the airplane is licensed, it is weighed, and a basic empty weight and C.G. location is computed (basic empty weight consists of the standard empty weight of the airplane plus the optional equipment). Using the basic empty weight and C.G. location, the pilot can easily determine the weight and C.G. position for the loaded airplane by computing the total weight and moment and then determining whether they are within the approved envelope.

The basic empty weight and C.G. location are recorded in the Weight and Balance Data Form (Figure 6-7) and the Weight and Balance Record (Figure 6-9). The current values should always be used. Whenever new equipment is added or any modification work is done, the mechanic responsible for the work is required to compute a new basic empty weight and C.G. position and to write these in the Aircraft Log Book and the Weight and Balance Record. The owner should make sure that it is done.

A weight and balance calculation is necessary in determining how much fuel or baggage can be boarded and still remain within allowable limits. Check calculations prior to adding fuel to insure against improper loading.

The following pages are forms used in weighing an airplane in production and in computing basic empty weight, C.G. position, and useful load. Note that the useful load includes usable fuel, baggage, cargo and passengers. Following this is the method for computing takeoff weight and C.G.

6.3 AIRPLANE WEIGHING PROCEDURE

At the time of licensing, Piper Aircraft Corporation provides each airplane with the basic empty weight and center of gravity location. This data is supplied by Figure 6-7.

The removal or addition of equipment or airplane modifications can affect the basic empty weight and center of gravity. The following is a weighing procedure to determine this basic empty weight and center of gravity location:

(a) Preparation

- (1) Be certain that all items checked in the airplane equipment list are installed in the proper location in the airplane.
- (2) Remove excessive dirt, grease, moisture, foreign items such as rags and tools from the airplane before weighing.
- (3) Defuel airplane. Then open all fuel drains until all remaining fuel is drained. Operate engine on each tank until all undrainable fuel is used and engine stops.

- (4) Fill to full capacity with oil and operating fluids.
- (5) Place pilot and copilot seats in a center position on the seat tracks. Put flaps in the fully retracted position and all control surfaces in the neutral position. Tow bar should be in the proper location and all doors closed.
- (6) Weigh the airplane inside a closed building to prevent errors in scale readings due to wind.

(b) Leveling

Level the airplane (refer to Figure 6-3) deflating the nose wheel tire to center bubble on level.

(c) Weighing - Airplane Basic Empty Weight

- (1) With the airplane level and brakes released, record the weight shown on each scale. Deduct the tare, if any, from each reading.

AIRPLANE AS WEIGHED
(Including full oil and operating fluids but no fuel)

Scale Position and Symbol	Scale Reading	Tare	Net Weight
Nose Wheel (N)			
Right Main Wheel (R)			
Left Main Wheel (L)			
Weight, as Weighed (T)			

WEIGHING FORM

Figure 6-1

(d) Center of Gravity

- (1) The following geometry applies to the PA-38-112 airplane when it is level. Refer to Leveling paragraph 6.3 (b).

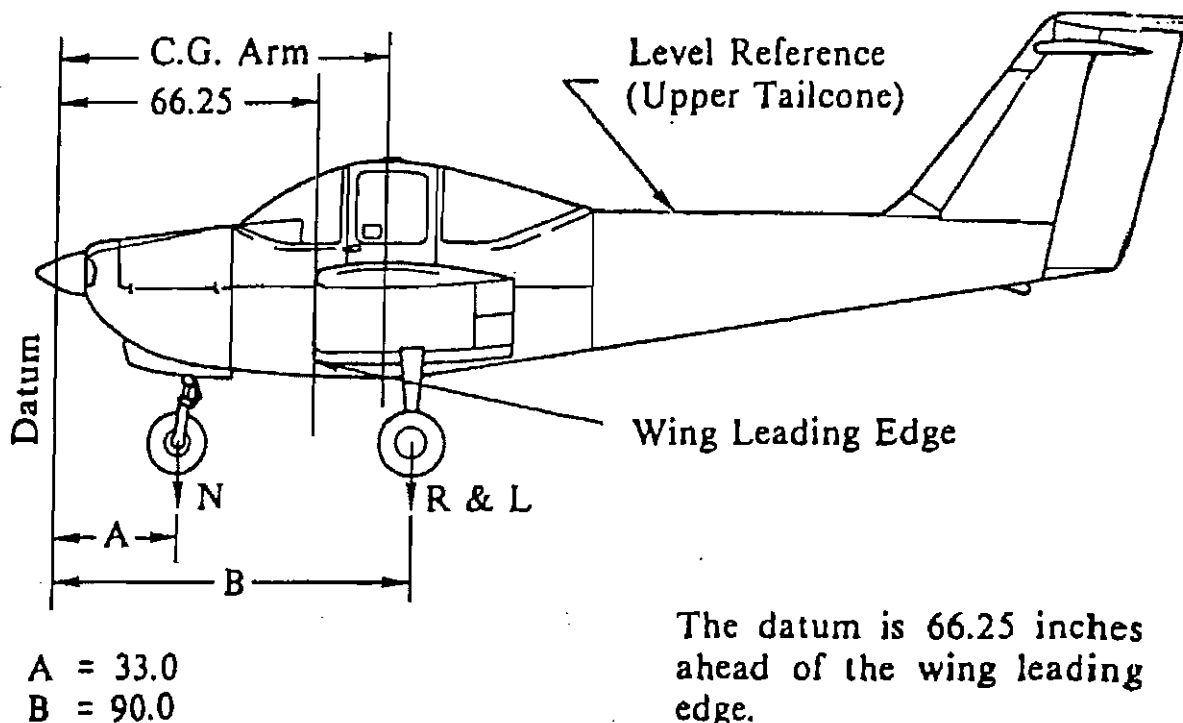

LEVELING DIAGRAM
Figure 6-3

- (2) The empty weight center of gravity (as weighed including optional equipment, full oil and operating fluids) can be determined by the following formula:

$$\text{C.G. Arm} = \frac{N(A) + (R + L)(B)}{T} \text{ inches}$$

Where: $T = N + R + L$

(e) Basic Empty Weight

Item	Weight (Lbs)	Arm x (Inches Aft of Datum)	= Moment (Lb-In.)
Weight (as Weighed)			
Unusable fuel (2 gal.)	12.0	75.4	905
Basic Empty Weight			

BASIC EMPTY WEIGHT

Figure 6-5

6.5 WEIGHT AND BALANCE DATA AND RECORD

The Basic Empty Weight, Center of Gravity location and Useful Load listed in Figure 6-7 are for the airplane as licensed at the factory. These figures apply only to the specific airplane serial number and registration number shown.

The basic empty weight of the airplane as licensed at the factory has been entered in the Weight and Balance Record (Figure 6-9). This form is provided to present the current status of the airplane basic empty weight and a complete history of previous modifications. Any change to the permanently installed equipment or modification which affects weight or moment must be entered in the Weight and Balance Record.

**SECTION 6
WEIGHT AND BALANCE**

**PIPER AIRCRAFT CORPORATION
PA-38-112, TOMAHAWK**

MODEL PA-38-112 TOMAHAWK

Airplane Serial Number _____

Registration Number _____

Date _____

AIRPLANE BASIC EMPTY WEIGHT

Item	Weight (Lbs)	C.G. Arm (Inches Aft of Datum)	Moment (Lb-In.)
Standard Empty Weight*	Actual		Computed
Optional Equipment			
Basic Empty Weight			

*The standard empty weight includes full oil capacity and 2.0 gallons of unusable fuel.

AIRPLANE USEFUL LOAD - NORMAL CATEGORY OPERATION

(Gross Weight) - (Basic Empty Weight) = Useful Load

Normal Category: (1670 lbs.) - (lbs.) = lbs.

Utility Category: (1670 lbs.) - (lbs.) = lbs.

THIS BASIC EMPTY WEIGHT, C.G. AND USEFUL LOAD ARE FOR THE AIRPLANE AS LICENSED AT THE FACTORY. REFER TO APPROPRIATE AIRCRAFT RECORD WHEN ALTERATIONS HAVE BEEN MADE.

WEIGHT AND BALANCE DATA FORM

Figure 6-7

PA-38-112	Serial Number	Description of Article or Modification	Registration Number		Page Number		
			Added (+) Removed (-)	Weight Change	Running Basic Empty Weight		
Date	Item No.		Wt. (Lb.)	Arm (In.)	Moment /100	Wt. (Lb.)	Moment /100
		As licensed					

WEIGHT AND BALANCE RECORD

Figure 6-9

**SECTION 6
WEIGHT AND BALANCE**

**PIPER AIRCRAFT CORPORATION
PA-38-112, TOMAHAWK**

PA-38-112	Serial Number	Description of Article or Modification	Added (+) Removed (-)	Registration Number			Page Number
				Wt. (Lb.)	Arm (In.)	Moment /100	
Item No.				Weight Change		Running Basic Empty Weight	
Date				Wt. (Lb.)	Moment /100	Wt. (Lb.)	Moment /100

WEIGHT AND BALANCE RECORD (cont)

Figure 6-9 (cont)

6.7 WEIGHT AND BALANCE DETERMINATION FOR FLIGHT

- (a) Add the weight of all items to be loaded to the basic empty weight.
- (b) Use the Loading Graph (Figure 6-15) to determine the moment of all items to be carried in the airplane.
- (c) Add the moment of all items to be loaded to the basic empty weight moment.
- (d) Divide the total moment by the total weight to determine the C.G. location.
- (e) By using the figures of item (a) and item (d) (above), locate a point on the C.G. range and weight graph (Figure 6-17). If the point falls within the C.G. envelope, the loading meets the weight and balance requirements.

	Weight (Lbs.)	Arm Aft Datum (Inches)	Moment (Lb-In.)
Basic Empty Weight	1169.0	73.2	85570
Pilot and Passenger**	340.0	85.5	29070
Fuel (30 Gallon Maximum)	61.0	75.4	4599
Baggage (100 Lbs. Maximum)*	100.0	115.0	11500
Total Loaded Airplane	1670.0	78.3	130739

The center of gravity (C.G.) of this sample loading problem is at 78.3 inches aft of the datum line. Locate this point (78.3) on the C.G. range and weight graph. Since this point falls within the weight - C.G. envelope, this sample loading meets the weight and balance requirements.

IT IS THE RESPONSIBILITY OF THE PILOT AND AIRCRAFT OWNER TO INSURE THAT THE AIRPLANE IS LOADED PROPERLY.

* No baggage allowed for spins.

** Occupant C.G. is shown with the seats in the fourth notch from the most forward position. See Figure 6-14 for the seat position and corresponding arm aft datum.

SAMPLE LOADING PROBLEM (NORMAL CATEGORY)

Figure 6-11

**SECTION 6
WEIGHT AND BALANCE**

**PIPER AIRCRAFT CORPORATION
PA-38-112, TOMAHAWK**

	Weight (Lbs.)	Arm Aft Datum (Inches)	Moment (Lb-In.)
Basic Empty Weight			
Pilot and Passenger**		85.5	
Fuel (30 Gallon Maximum)		75.4	
Baggage (100 Lbs. Maximum)*		115.0	
Total Loaded Airplane			

Totals must be within approved weight and C.G. limits. It is the responsibility of the airplane owner and the pilot to insure that the airplane is loaded properly. The Basic Empty Weight C.G. is noted on the Weight and Balance Data Form (Figure 6-7). If the airplane has been altered, refer to the Weight and Balance Record for this information.

* No baggage allowed for spins.

** Occupant C.G. is shown with the seats in the fourth notch from the most forward position. For other seat locations and corresponding arm aft datum see Figure 6-14.

WEIGHT AND BALANCE LOADING FORM

Figure 6-13

Seat Position	Arm Aft Datum (Inches)
FWD 1	80.8
2	82.3
3	83.9
4	85.5
5	87.5
AFT 6	89.5

SEAT POSITION AND CORRESPONDING ARM AFT DATUM

Figure 6-14

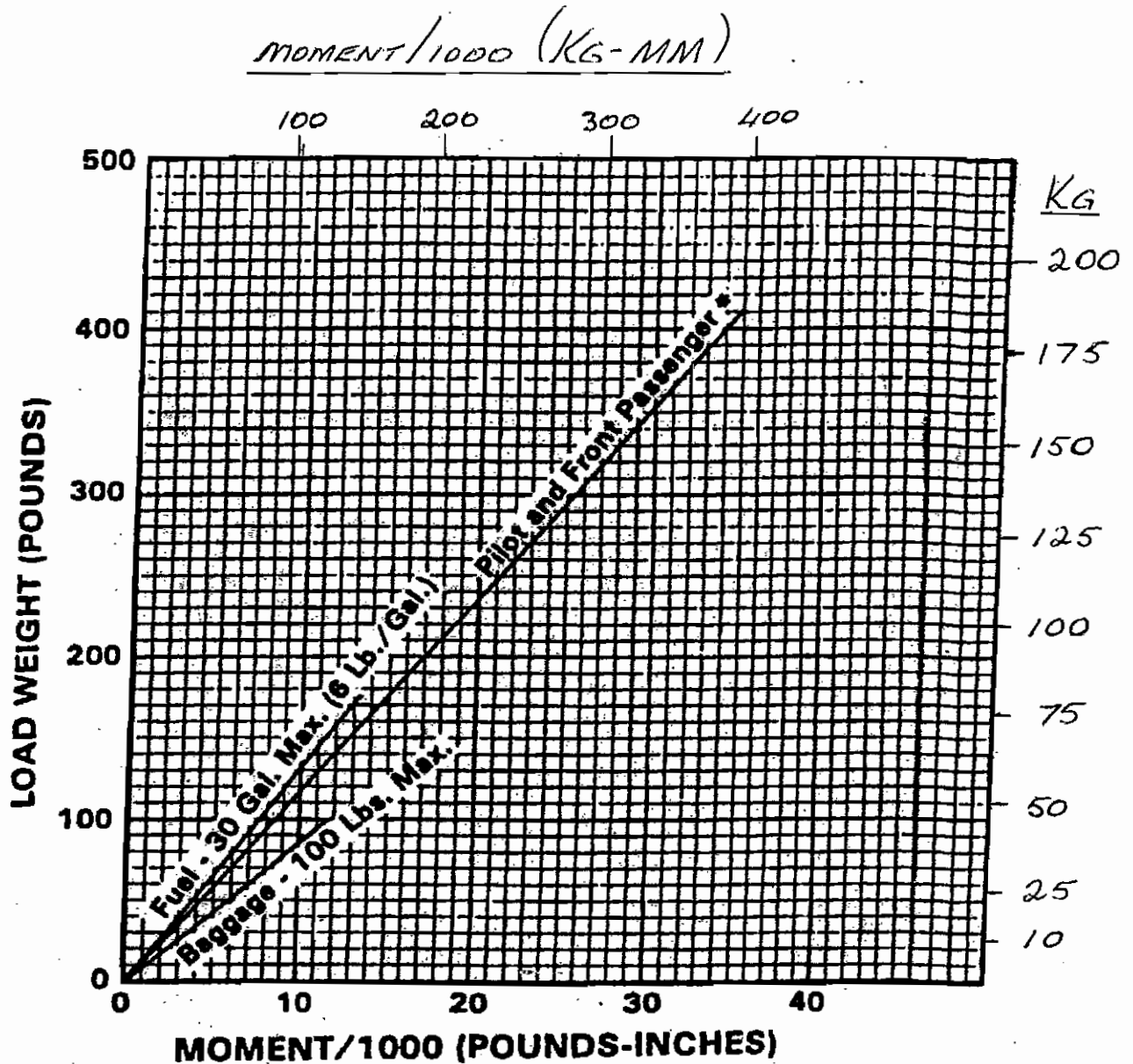

*Loading graph is shown with the seats in the fourth notch from the most forward position. If C.G. falls near the forward or aft limit, occupant seat positions are important; and moments should be calculated by multiplying pilot and passenger weight by appropriate arm aft datum (see Figure 6-14), rather than determined by the loading graph.

LOADING GRAPH
Figure 6-15

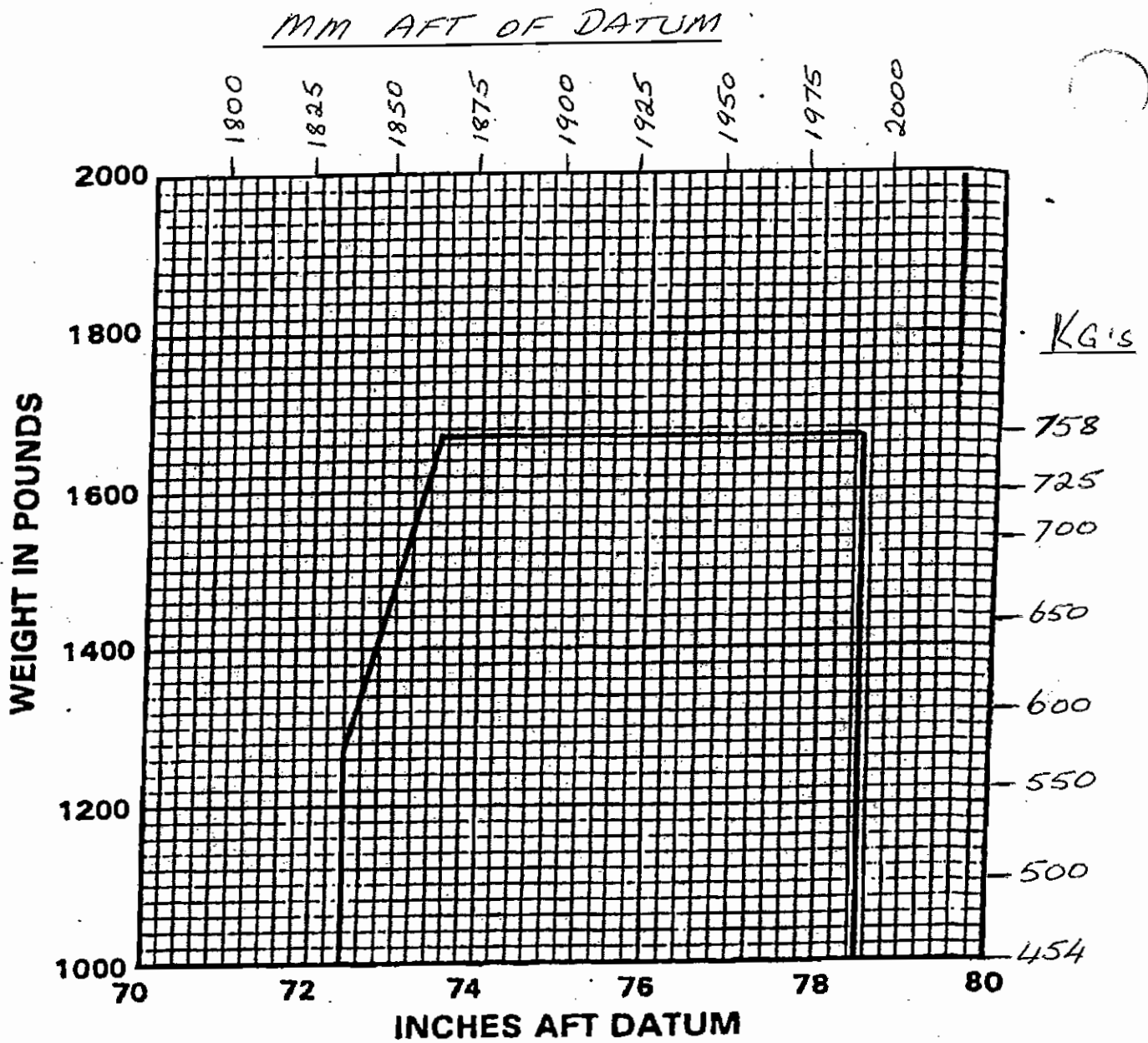

C. G. RANGE AND WEIGHT
Figure 6-17

(b) Engine and Engine Accessories (cont)

Item No.	Item	Mark if Instl.	Weight (Pounds)	Arm (In.) Aft Datum	Moment (Lb-In.)
19 A	Air Filter, Donaldson P12-0494	—	0.4	24.5	10
21 A	Gascolator, Piper Dwg. 77908-4	—	0.6	39.5	24
23 A	Fuel Quick Drains (2) Curtis CCA1550	—	0.05	79.3	4
25 A	Oil Filter - Lyc. LW13215* (Champion CH 48110) Cert. Basis - TC E223	—	2.5	40.0	100
27 A	Engine Primer Pump** Essex K2406-SAE-2	—	0.4	24.4	10

*With adapter

**Standard on aircraft with serial nos. 38-79A0001 and up. Optional on earlier aircraft.

SECTION 6
WEIGHT AND BALANCE

PIPER AIRCRAFT CORPORATION
PA-38-112, TOMAHA WK

Item No.	(c) Landing Gear and Brakes	Item	Mark if Instl.	Weight (Pounds)	Arm (In.) Aft Datum	Moment (Lb-In.)
31		Two Main Wheel Assemblies	—	25.3	90.0	2277
B		a. Cleveland Aircraft Products Wheel Assy., Piper PS50035-17	—	9.5	90.0	855
		Cert. Basis - TSO C26a	—			
		Brake Assy., Piper PS50121-6 and -7	—	4.3*	90.0	387
		Cert. Basis - TSO C26a	—			
B		b. 5.00-5 4 ply tires, Piper PS501191-1, with Regular tubes, Piper PS50119-100	—	11.5	90.0	1035
		Cert. Basis - TSO C62	—			
33		One Nose Wheel Assembly	—	13.7	33.0	452
B		a. Cleveland Aircraft Products Wheel Assy., Piper PS50035-12 or -15	—			
		Cert. Basis - TSO C26a	—	7.9	33.0	261
B		b. 5.00-5 4 ply tires, Piper PS50019-1, with Regular tube, Piper PS50019-100	—	5.8	33.0	191
		Cert. Basis - TSO C62	—			

*Includes two axles

Item No.	Item	Mark if Instl.	Weight (Pounds)	Arm (In.) Aft Datum	Moment (Lb-In.)
(c) Landing Gear and Brakes (cont)					
35	Two Main Wheel Assemblies	_____	34.2	90.0	3078
A	a. Cleveland Aircraft Products Wheel Assy., No. 40-59D Cert. Basis - TSO C26a Brake Assy., No. 30-53A Cert. Basis - TSO C26a	_____	14.3	90.0	1287
A	b. 6.00-6 Type III 4 ply Rating Tires with Regular tubes Cert. Basis - TSO C62	_____	4.9*	90.0	441
37	One Nose Wheel Assembly	_____	15.0	90.0	1350
A	a. Cleveland Aircraft Products Wheel Assy., Piper PS50035-23 Cert. Basis - TSO C26a	_____	19.3	33.0	637
A	b. 6.00-6 Type III 4 ply Rating Tire with Regular tube Cert. Basis - TSO C62	_____	11.8	33.0	390
39	Parking/Handbrake Piper Dwg. 77420-2	_____	7.5	33.0	248
		_____	1.6	56.9	91

*Includes two axles

SECTION 6
WEIGHT AND BALANCE

PIPER AIRCRAFT CORPORATION
PA-38-112, TOMAHAWK

Item No.	Electrical Equipment Item	Mark if Instl.	Weight (Pounds)	Arm (In.) Aft Datum	Moment (Lb-In.)
41 A	Battery 12V, 25 A.H., Rebat Model S-25	—	21.9	42.6	933
43 A	Voltage Regulator, Wico Electric No. X18150 or Lamar FVR 3024	—	0.9	48.0	44
45 A	Overvoltage Relay, Wico Electric No. X16799	—	0.5	48.2	24
47 A	Stall Warning Device, Safe Flight Instrument Corp. C52207-4	—	0.2	48.5	10
49 A	Stall Warning Horn, Piper Dwg. 77976-2 Safeflight 53534-1	—	0.2	48.5	10
51	Instrument Lights Instl. (Supplemental) Piper Dwg. 77534-2	—	0.6	64.5	39
53	Emergency Light Instl. Piper Dwg. 77535-2	—	0.6	56.7	34

(e) Instruments						
Item No.	Item	Mark if Instl.	Weight (Pounds)	Arm (In.) Aft Datum	Moment (Lb-In.)	
57 A	Compass, Airpath C-2200 L4B, Piper Dwg. 77970-2 Cert. Basis - TSO C7c	—	0.9	70.5	64	
59 B	Airspeed Indicator, Piper Dwg. 61905-2 Cert. Basis - TSO C2b	—	0.6	61.9	37	
61 A	Tachometer, Piper Dwg. 77980-2	—	0.7	61.3	43	
62 A	Altimeter a. Piper PS50008-10 b. United Instr., Inc. - 5934 PA-1 Piper Dwg. 77970	—	1.0	61.0	61	
63 B	Altimeter, Piper PS50008-2-2 Cert. Basis - TSO C10b	—	1.0	61.0	61	

SECTION 6
WEIGHT AND BALANCE

PIPER AIRCRAFT CORPORATION
PA-38-112, TOMAHAWK

(e) Instruments (cont)	Item	Mark if Instl.	Weight (Pounds)	Arm (In.) Aft Datum	Moment (Lb-In.)
65 A	Engine Cluster.* Piper Dwg. 77913-2 or -7	—	0.6	62.5	38
67 A	Fuel Gauges (Left and Right) Piper Dwg. 77985-2 and -3	—	0.4	63.5	26
69	Outside Air Temp. Gauge Piper Dwg. 99479-2 or -3	—	0.2	75.1	15

*Ammeter, Oil Temp., Oil Pressure, Fuel Pressure

(f) Miscellaneous		Item	Mark if Instl.	Weight (Pounds)	Arm (In.) Aft Datum	Moment (Lb.-In.)
Item No.	Item					
77 A	Seat Belts (2) and Shoulder Harness (2) ea. Piper Dwg. 77767-2 and 3 TSO-C-22F	—	2.0	95.0	190	
79 A	Ash Tray, Grand Rapids Metal Craft 2A-21560	—	0.5	86.6	43	
81 A	Pilot's Operating Handbook	—	2.6	—	—	
83 A	Flow Strips Inboard	—	—	—	—	
	Outboard	—	—	—	—	
(g) Engine and Engine Accessories (Optional Equipment)						
Item No.	Item	Mark if Instl.	Weight (Pounds)	Arm (In.) Aft Datum	Moment (Lb.-In.)	
87 C	Engine, Lycoming Model O-235-L2A (with Bendix Magnetos) Piper Dwg. 77650-3 Cert. Basis - Lyc. TC E223	—	252.0*	24.3	6124	

*Dry basic engine

SECTION 6
WEIGHT AND BALANCE

PIPER AIRCRAFT CORPORATION
PA-38-112, TOMAHAWK

(g) Engine and Engine Accessories (Optional Equipment) (cont)		Mark if Instl.	Weight (Pounds)	Arm (In.) Aft Datum	Moment (Lb-In.)
Item No.	Item				
89	Engine Primer Pump** Essex K2406-SAE-2	—	0.4	24.4	10
90	Oil Cooler Instl. Piper Dwg. 77896-2	—	4.0	33.5	134
(h) Propeller and Propeller Accessories (Optional Equipment)		Mark if Instl.	Weight (Pounds)	Arm (In.) Aft Datum	Moment (Lb-In.)
Item No.	Item				
	(i) Landing Gear and Brakes (Optional Equipment)				
103	Toe Brakes (Dual), Piper Dwg. 77825-3 & 77918-3	—	7.6*	49.4	375

*Right and Left
**Optional on aircraft with serial nos. 38-78A0001 through 38-78A0844. All aircraft included the engine primer pump.

(i) Landing Gear and Brakes
(Optional Equipment) (cont)

Item No.	Item	Mark if Instl.	Weight (Pounds)	Arm (In.) Aft Datum	Moment (Lb-In.)
104 C	6.00 x 6 Tire Assemblies (Complete) Piper Dwgs: 7775-3, 61889-2 & 61889-3	—	14.6*	67.6	987

(j) Electrical Equipment
(Optional Equipment)

Item No.	Item	Mark if Instl.	Weight (Pounds)	Arm (In.) Aft Datum	Moment (Lb-In.)
119	Night Lighting Piper Dwg. 77920-3 (Includes Instrument, Landing, Tail and Navigation -Strobe lights with Power Supply and Harnesses)	—	8.3	81.3	675

*Weight and moment difference between 5.00 x 5 and 6.00 x 6 Tire Assemblies. (Optional 6.00 x 6 Tire Assemblies must include two main wheel assemblies and one nose wheel assembly.)

SECTION 6
WEIGHT AND BALANCE

PIPER AIRCRAFT CORPORATION
PA-38-112, TOMAHAWK

(j) Electrical Equipment
(Optional Equipment) (cont)

Item No.	Item	Mark if Instl.	Weight (Pounds)	Arm (In.) Aft Datum	Moment (Lb-In.)
121	Heated Pitot Head, Piper Dwg. 77929-4	—	0.4	79.2	32
123	Cabin Speaker, Magitran P-5B	—	0.6	92.3	56
125	Auxiliary Power Receptacle, Piper Dwg. 77583-2	—	5.7	88.0	502
127	External Power Cable, Piper Dwg. 62355-2	—	4.6	as installed	
131	Carburetor Air Temperature Indicator Instl. Piper Dwg. 77531-2	—	2.0	51.4	103

Item No.	(k) Instruments (Optional Equipment)	Item	Mark if Instl.	Weight (Pounds)	Arm (In.) Aft Datum	Moment (Lb-In.)
135 C	Airspeed Indicator, (True Airspeed)	Piper Dwg. 61906-2 Cert. Basis - TSO C2b	—	0.6	61.9	37
137 C	Altimeter, Piper	PS50008-3-2	—	1.0	61.0	61
139	Attitude Gyro,	Piper Dwg. 77970-5 Cert. Basis - TSO C4c	—	2.2	59.5	131
141	Directional Gyro,	Piper Dwg. 77970-5 Cert. Basis - TSO C5c	—	2.6	59.8	156
143	Vertical Speed Indicator,	Piper Dwg. 77970-3 or -4 or -5 Cert. Basis - TSO C8c	—	1.0	66.0	66
145	Turn and Slip Indicator,	Piper Dwg. 77970-4 or -5 Cert. Basis - TSO C3b	—	2.6	59.8	156

SECTION 6
WEIGHT AND BALANCE

PIPER AIRCRAFT CORPORATION
PA-38-112, TOMAHAWK

Item No.	Instruments (Optional Equipment) (cont)	Item	Mark if Instl.	Weight (Pounds)	Arm (In.) Aft Datum	Moment (Lb-In.)
147	Outside Air Temp. Gauge, Piper Dwg. 99479-0,-2 or -3		—	0.2	75.1	15
149	Clock, CA7613 Piper Dwg. 77970		—	0.4	62.5	25
151	Hour Meter, Hobbs M-15006-15, Datcon 773, Piper Dwg. 77946-2		—	0.3	61.3	19
153	Vacuum Gauge, UMA 3-200-1 Piper Dwg. 77970-5		—	0.1	62.0	7

(l) Autopilots (Optional Equipment)		Item	Mark if Instl.	Weight (Pounds)	Arm (In.) Aft Datum	Moment (Lb-In.)
Item No.						
(m) Radio Equipment (Optional Equipment)						
Item No.	Item	Mark if Instl.	Weight (Pounds)	Arm (In.) Aft Datum	Moment (Lb-In.)	
171	King Avionics Instl. a. Piper Dwg. 09181-2 b. Piper Dwg. 09349-2 or 09217-3 or 09603-2 or 09604-3 or 09747-2	—	13.5	78.6	1061	
173	King Avionics Instl. Piper Dwg. 09217-2 or 09604-2	—	11.7	81.4	952	
175	King Avionics Instl. (With Glideslope) Piper Dwg. 09349-3 or 09603-3 or 09747-3	—	10.5	83.8	880	
		—	13.5	76.0	1026	

SECTION 6
WEIGHT AND BALANCE

PIPER AIRCRAFT CORPORATION
PA-38-112, TOMAHAWK

(m)	Radio Equipment (Optional Equipment) (cont)	Item No.	Item	Mark if Instl.	Weight (Pounds)	Arm (In.) Aft Datum	Moment (Lb.-In.)
		177	King Avionics Instl., Piper Dwg. 08316-2 or 08321-2	—	9.5	85.8	815
		179	King Avionics Instl., Piper Dwg. 08316-3 or 08321-3	—	9.7	83.8	813
		181	King Avionics Instl., (Second Nav/Comm) Piper Dwg. 08316-4 or 08321-4	—	17.6	72.0	1267
		182	King Avionics Instl., (Second Nav/Comm with Glide Slope) Piper Dwg. 08316-5 or 08321-5	—	17.8	71.1	1266

(m) Radio Equipment
(Optional Equipment) (cont)

Item No.	Item	Mark if Instl.	Weight (Pounds)	Arm (In.) Aft Datum	Moment (l.b.-In.)
191	Narco Avionics Instl., Piper Dwg. 09188-2 or 09608-2 or 08418-2	_____	10.7	88.7	949
193	Narco Avionics Instl. with Glide Slope Piper Dwg. 08418-3	_____	10.9	88.3	962
195	Narco Avionics Instl. (Second Nav/Comm) Piper Dwg. 08418-4	_____	17.7	78.2	1384
197	Narco Avionics Instl. (Second Nav/Comm with Glide Slope) Piper Dwg. 08418-5	_____	17.9	78.0	1396

**SECTION 6
WEIGHT AND BALANCE**

**PIPER AIRCRAFT CORPORATION
PA-38-112, TOMAHAWK**

THIS PAGE INTENTIONALLY LEFT BLANK

(m) Radio Equipment
(Optional Equipment) (cont)

Item No.	Item	Mark if Instl.	Weight (Pounds)	Arm (In.) Aft Datum	Moment (Lb-In.)
201	Collins Avionics Instl., Piper Dwg. 09194-2 or 09217-4 or 09606-2 or 09604-4 or 09748-2 or 08384-2 or 08387-2	—	11.6	83.3	966
203	Collins Avionics Instl., (with Glide Slope) Piper Dwg. 08384-3 or 08387-3	—	14.4	77.9	1122
205	Collins Avionics Instl., (Second Nav/Comm) Piper Dwg. 08384-4 or 08387-4	—	24.0	69.5	1668
207	Collins Avionics Instl., (Second Nav/Comm with Glide Slope) Piper Dwg. 08384-5 or 08387-5	—	26.8	68.1	1825

SECTION 6
WEIGHT AND BALANCE

PIPER AIRCRAFT CORPORATION
PA-38-112, TOMAHAWK

Item No.	Radio Equipment (Optional Equipment) (cont)	Item	Mark if Instl.	Weight (Pounds)	Arm (In.) Aft Datum	Moment (l.b.-In.)
211	Second Nav Comm	Instl..	Piper Dwg. 09347-2	8.7	68.5	596
213	Second Nav Comm	Instl..	Piper Dwg. 09189-2	7.2	75.3	542
215	Second Nav Comm	Instl..	Piper Dwg. 09195-2	8.1	69.1	560
217	Audio Selector Panel	Instl..	Piper Dwg. 09183-2	2.3	60.4	139
219	Audio Selector Panel	Instl..	Piper Dwg. 09190-2 or 08421-2	1.9	71.2	135
221	Audio Selector Panel	Instl..	Piper Dwg. 09196-2 or 08388-5	2.2	68.0	150
223	Audio Selector Panel	Instl..	(Aud-250). Piper Dwg. 09196-3	1.9	69.0	131
225	Audio Instl. (King KA-134)	Instl..	Piper Dwg. 09596-2	0.1	61.0	6

(m) Radio Equipment
(Optional Equipment) (cont)

Item No.	Item	Mark if Instl.	Weight (Pounds)	Arm (In.) Aft Datum	Moment (Lb.-In.)
227	Transponder Instl., Piper Dwg. 09197-2 or 08388-4	_____	2.2	58.8	129
229	Transponder Instl., Piper Dwg. 09184-2 or 08327-4	_____	3.3	57.2	189
231	Transponder Instl., Piper Dwg. 09191-2 or 08421-4	_____	2.5	61.9	155
233	ADF Instl., Piper Drawing 09191-2 or 08421-3	_____	5.7	84.1	479
235	ADF Instl., Piper Drawing 09452-2 or 08388-3	_____	5.1	87.4	446
237	ADF Instl., Piper Drawing 09185-2 or 08327-3	_____	6.3	84.1	530
239	Glide Slope/Marker Beacon Instl., Piper Dwg. 09193-2 (Exchange for Nav I Indicator)	_____	0.2*	63.0	13

*Weight and moment difference between Nav I Indicator and Glide Slope Installation.

SECTION 6
WEIGHT AND BALANCE

PIPER AIRCRAFT CORPORATION
PA-38-112, TOMAHAWK

(m) Item No.	Radio Equipment (Optional Equipment) (cont) Item	Mark if Instl.	Weight (Pounds)	Arm (In.) Aft Datum	Moment (Lb-In.)
241	Glide Slope Instl. (Collins). Piper Dwg. 09199-2 (Exchange for Nav 1 Ind.)	—	2.3*	48.1	111
243	Marker Beacon Instl.. Piper Dwg. 09187-2 or 09598-2 or 08327-2	—	0.6	63.0	38
245	Marker Beacon Instl.. Piper Dwg. 09201-2 or 08388-2	—	0.7	63.0	44
247	Encoding Altimeter Instl.. Piper Dwg. 09127-0 or -2 (United) or 08331-2 or 08331-4 or 08331-6	—	1.9	63.0	120
249	Encoder Instl. - Blind Piper Dwg. 09612-2 (United) or 08331-3 or 08331-5 or 08331-7	—	1.5	47.0	71

*Weight and moment difference between Nav 1 Indicator and Glide Slope Installation.

(m) Radio Equipment
 (Optional Equipment) (cont)

Item No.	Item	Mark if Instl.	Weight (Pounds)	Arm (In.) Aft Datum	Moment (Lb-In.)
251	Emergency Locator Transmitter (Narco) ELT 10	_____	3.5**	98.0	343
253	Emergency Locator Transmitter (CCC) CIR-11	_____	1.7**	98.0	167
255	Indicator Instl., Nav Exchange Piper Dwg. 08332-2 or 08332-4	_____	.6	60.0	36
257	Indicator Instl., Nav Exchange Piper Dwg. 08332-3	_____	.5	60.0	30

**Weight includes antenna and cable.

SECTION 6
WEIGHT AND BALANCE

PIPER AIRCRAFT CORPORATION
PA-38-112, TOMAHAWK

(n) Item No.	Miscellaneous (Optional Equipment) Item	Mark if Instl.	Weight (Pounds)	Arm (In.) Aft Datum	Moment (Lb-In.)
301	Stainless Steel Control Cables Piper Dwg. 77825-4, -5	—	—	—	—
303	Assist Step, Piper Dwg. 77768-2 and -3	—	1.9 (ea.)	112.5	214
305 C	Inertia Safety Belts, 4 point harness (2) 0.8 lbs. each, Piper Dwg. 77824-2	—	1.6	108.0	173
307	Sun Visors (2) Piper Dwg. 77757-3 & 77725-2	—	1.3	71.2	92
309	Tow Bar Piper Dwg. 77503-2	—	1.3	105.1	137
311	Vacuum System, Piper Dwg. 77948, 61998-2, 61999-2	—	3.9*	42.6	166

* Pump, regulator, filter and hoses.

(n) Miscellaneous
(Optional Equipment) (cont)

Item No.	Item	Mark if Instl.	Weight (Pounds)	Arm (In.) Aft Datum	Moment (Lb-In.)
313	Fire Extinguisher Instl. Piper Dwg. 77803-2	—	5.3	101.5	538
315	Document Container Piper Dwg. 77555-2	—	1.5	117.3	176
317	Static Wicks, set of seven Piper Dwg. 77886-2	—	—	—	—
319	Glove Compartment Piper Dwg. 61939-2	—	0.9	57.2	52
321	Engine Breather Tube Insulation Instl. Piper Dwg. 77540-2	—	—	—	—

TOTAL OPTIONAL EQUIPMENT

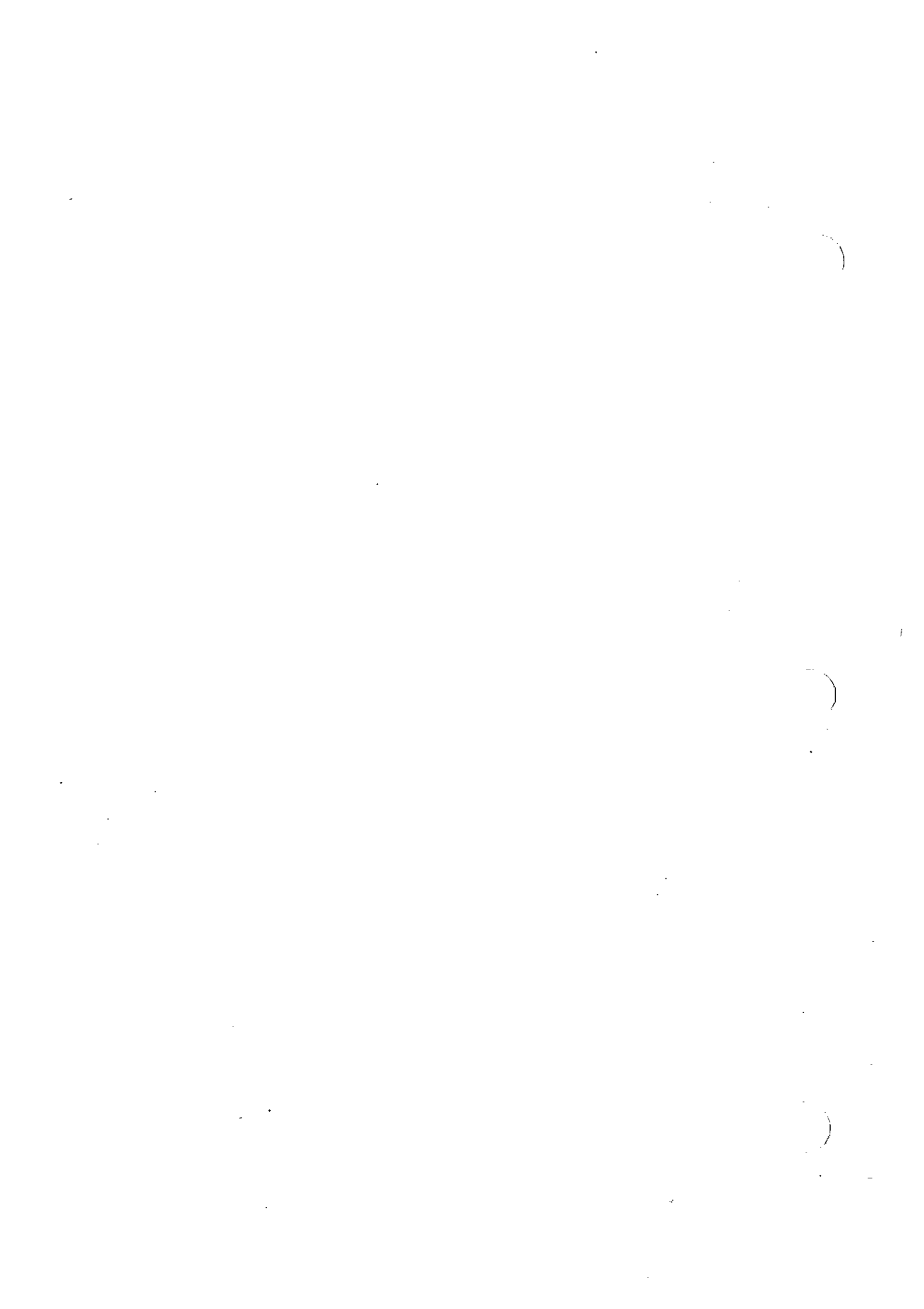
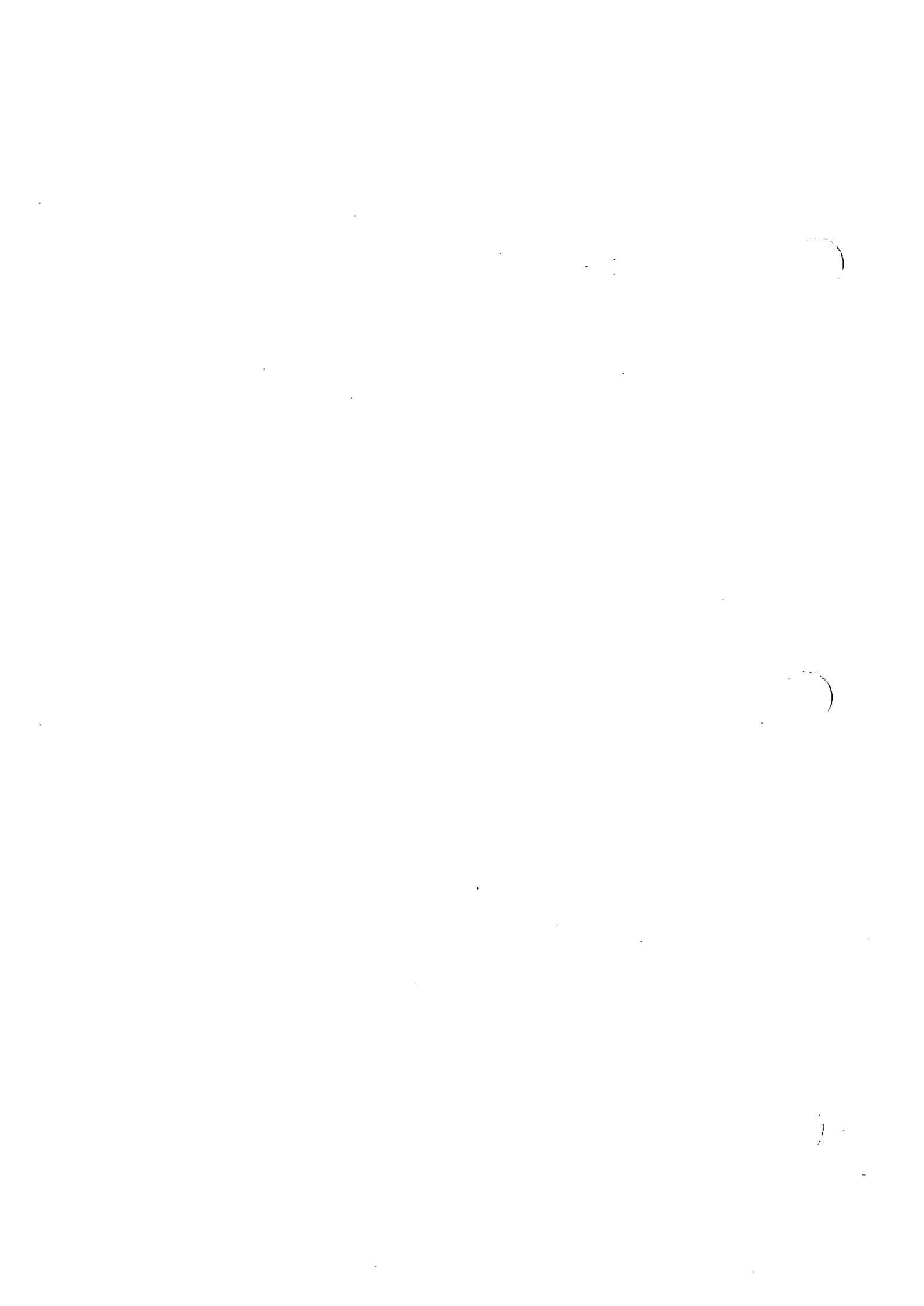

TABLE OF CONTENTS

SECTION 7

DESCRIPTION AND OPERATION OF THE AIRPLANE AND ITS SYSTEMS

Paragraph No.		Page No.
7.1	The Airplane	7-1
7.3	Airframe.....	7-1
7.5	Engine and Propeller.....	7-2
7.7	Landing Gear and Brakes	7-3
7.9	Flight Controls	7-5
7.11	Engine Controls	7-6
7.13	Fuel System	7-6
7.15	Electrical System	7-8
7.17	Instrument Panel	7-13
7.19	Vacuum System	7-15
7.21	Pitot-Static System.....	7-16
7.23	Heating and Ventilating System.....	7-19
7.25	Cabin Features	7-19
7.27	Baggage Area.....	7-21
7.29	Stall Warning	7-21
7.31	Finish	7-21
7.33	Emergency Locator Transmitter	7-21
7.35	Serial Number Plates	7-23
7.37	Fire Extinguisher (Portable)	7-24
7.39	Intercom System	7-24



SECTION 7

DESCRIPTION AND OPERATION OF THE AIRPLANE AND ITS SYSTEMS

7.1 THE AIRPLANE

The Piper Tomahawk is a single-engine, fixed gear, low wing monoplane of all metal construction. It has two-place seating and a one hundred pound baggage capacity.

7.3 AIRFRAME

The primary structure, with the exception of the steel tube engine mount, steel landing gear components and isolated areas, is of aluminum alloy construction. Fiberglass and thermoplastic are used in the engine cowling and in the extremities -- the wing tips, fairings, etc. -- and in nonstructural components throughout the airplane.

The fuselage is a conventional, all-metal, semi-monocoque structure with riveted skin. The two cockpit doors, one on each side of the fuselage, are hinged forward, allowing entrance and exit across wing walks which extend to the trailing edge of each wing. Four large windows -- including a windshield and a rear window, each of a one piece, wrap-around design, and two side windows, one in each door -- provide an all-around view from the cockpit. Removable access panels on each side of the fuselage forward of the cockpit aid in inspection and maintenance of equipment aft of the firewall and forward of the instrument panel.

Each wing is a full cantilever construction incorporating a laminar flow, NASA GA (W)-1 airfoil section. The wings are all metal with the exception of the removable thermoplastic wing tips. An I-beam main spar extends through the length of each wing and into the center of the fuselage where the spars are joined with high strength butt fittings, making, in effect, one continuous main spar. The main spar is attached to each side of the fuselage and to the center fuselage tunnel. An aft spar in each wing extends from the wing tip to the wing root and is bolted to the side of the fuselage.

The empennage is a T-tail configuration with a fixed horizontal stabilizer mounted atop the vertical fin.

7.5 ENGINE AND PROPELLER

The PA-38-112 is powered by a Lycoming O-235-L2C or O-235-L2A four cylinder, direct drive, horizontally opposed engine rated at 112 horsepower at 2600 RPM. It is equipped with a starter, a 60 amp 14 volt alternator, a shielded ignition, two magnetos, vacuum pump drive, a fuel pump, and an induction air filter.

The engine cowlings are cantilever structures attached at the firewall and split horizontally. The metal upper cowling contains two top-hinged access panels, one on either side of the engine. The fiberglass lower cowling is a one piece structure with integral air scoops. Both cowlings can be completely removed with the propeller in place.

The engine mount is constructed of tubular steel and is rigidly mounted to the firewall. The engine is attached with dynafocal insulators to reduce vibration. The engine mount includes a provision for the attachment of the nose gear.

Cooling of the engine and accessories is by down draft air flow. Air enters through openings on each side of the propeller and is carried through a pressure baffle system around the engine and to a fixed exit in the lower cowling. Air for cockpit and carburetor heat also enters through the nose cowling to be ducted to the heater shroud on the muffler.

An oil cooler installation is available as optional equipment. The cooler is mounted to the left rear engine baffle and incorporates a low temperature bypass system. A winterization plate is provided to restrict air during winter operation. (See Winterization in Handling and Servicing Section.)

Carburetor induction air enters a chin scoop intake in the lower cowling and flows directly through a filter and into the carburetor air box. The air box incorporates a positive shut-off carburetor heat intake so that when carburetor heat is selected, induction air is drawn through a hose from the muffler shroud.

The stainless steel exhaust system incorporates dual mufflers with heater shrouds to supply heated air for the cabin, the defroster system and the carburetor heat system. Exhaust gases are discharged through twin stacks protruding through the lower right of the bottom engine cowling.

A Sensenich 72CK-0-56 fixed pitch, two-bladed aluminum alloy propeller with a metal spinner is installed as standard equipment. The propeller has a 72 inch diameter with a 56 inch pitch which is determined at 75% of the diameter.

The pilot should read and follow the procedures recommended in the Lycoming Operator's Manual for this engine in order to obtain maximum engine efficiency and time between overhauls.

7.7 LANDING GEAR AND BRAKES

The fixed gear PA-38-112 is equipped with Cleveland 5.00 x 5 or optional Cleveland 6.00 x 6* wheels on all three gears (Figure 7-1). Cleveland single disc hydraulic brake assemblies are installed on the main gear. All three wheels carry 5.00 x 5 or optional 6.00 x 6* four ply tube type tires.

The nose gear strut is of the air-oil type with a normal static load extension of 3 inches. A tow bar fitting is incorporated into the strut. The main gear struts are single-leaf steel springs. The springs, axles and fittings of the main gear are interchangeable.

The nose gear is steerable by use of the rudder pedals through a 60 degree arc, 30 degrees each side of center. The optional toe brakes, if installed, aid in the execution of tighter turns.

The standard brake system includes a master cylinder and brake fluid reservoir which is installed on the top left forward face of the firewall. The parking brake handle/knob is mounted below and near the center of the instrument panel (Figure 7-5). To set the parking brake, first depress and hold the toe brake pedals and then pull out on the parking brake handle/knob. To release the parking brake, first depress and hold the toe brake pedals and then push in on the parking brake handle/knob.

WARNING

No braking action will occur if handle/knob is pulled prior to brake application

When the optional dual toe brake system is installed, a toe brake pedal is included on each rudder pedal. Each toe brake includes a separate brake cylinder above the pedal. With this installation, the left or the right brake may be operated separately to aid in steering and turning.

* 6.00 x 6 wheel assemblies are standard on aircraft with serial nos. 38-81A0001 and up. Optional on earlier aircraft.

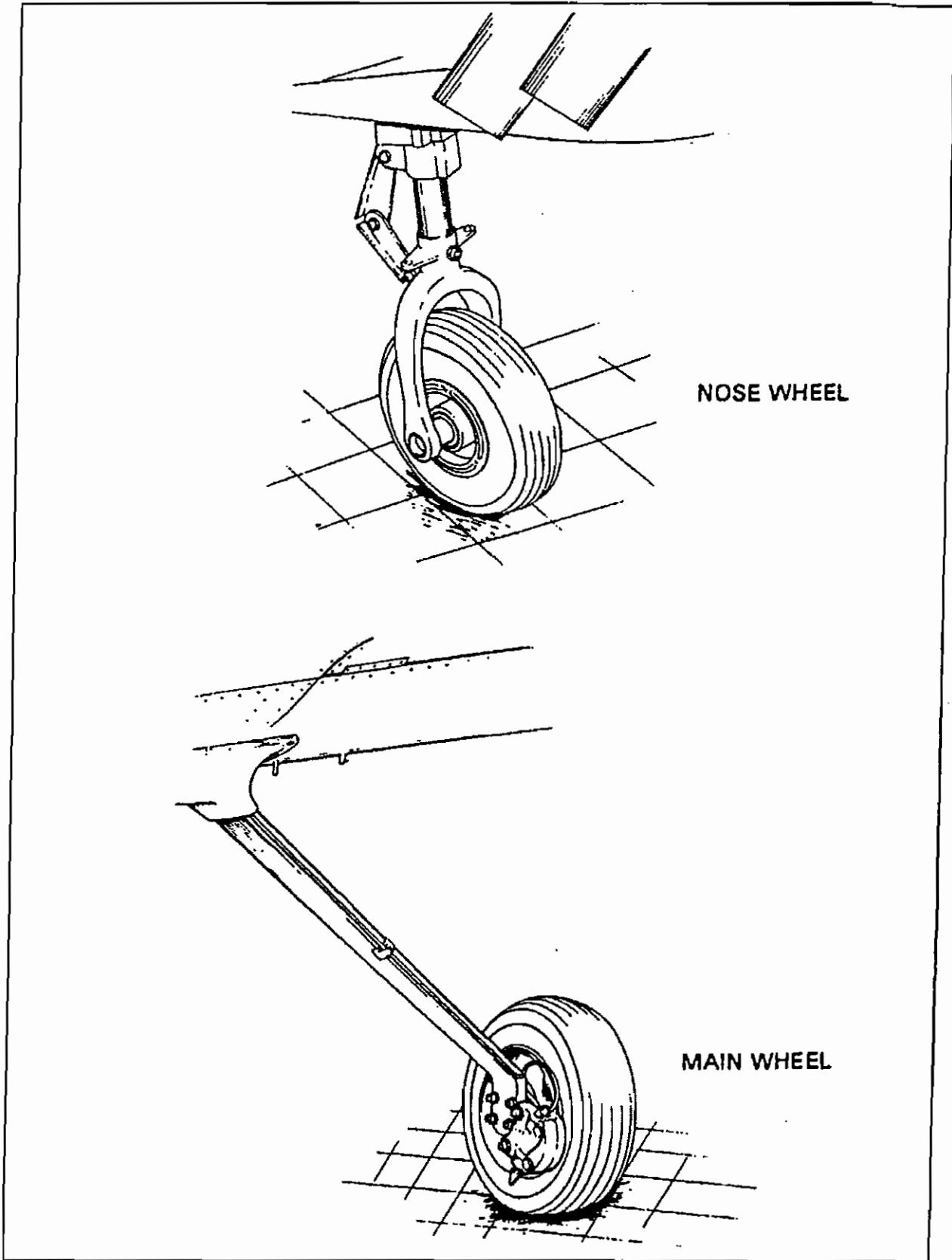

WHEEL ASSEMBLIES
Figure 7-1

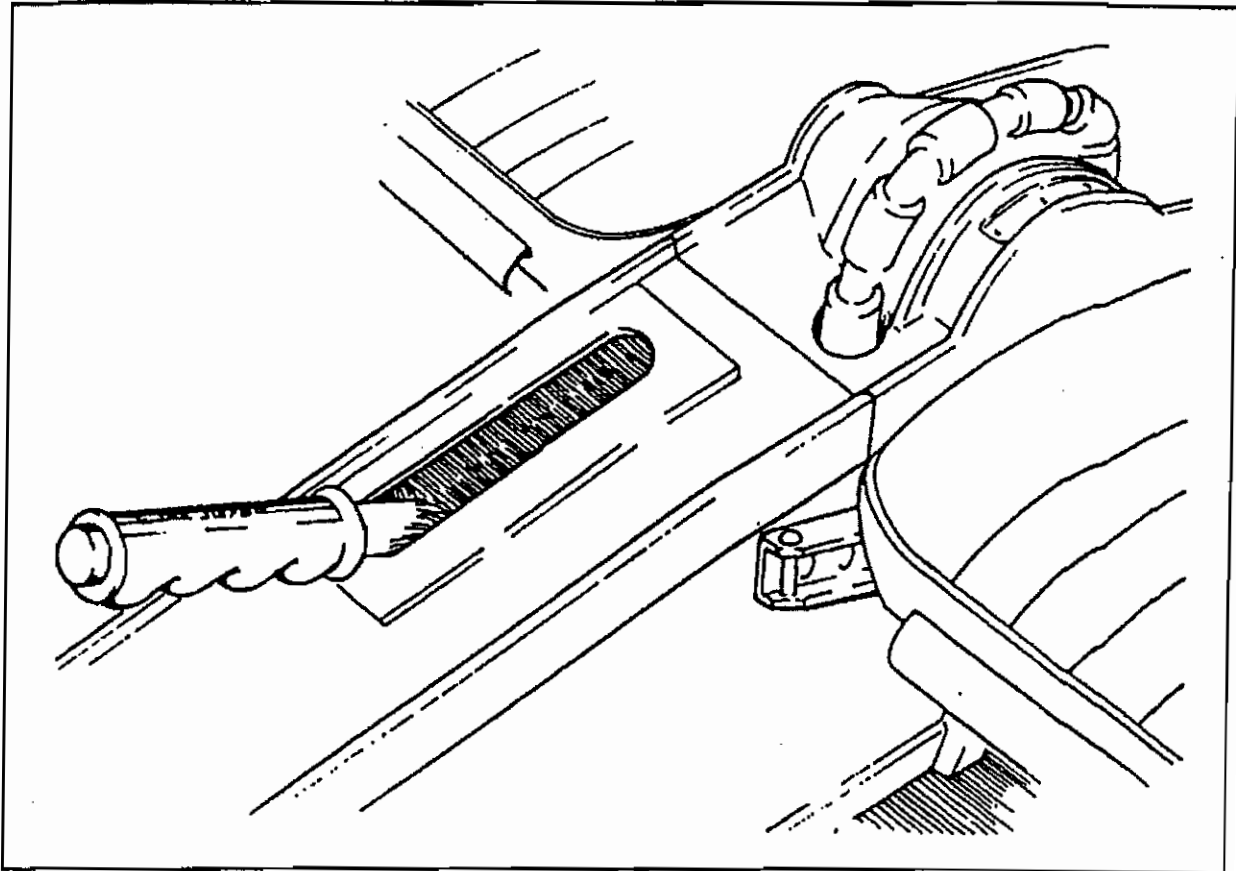

FLIGHT CONTROL CONSOLE

Figure 7-3

7.9 FLIGHT CONTROLS

Dual flight controls are standard equipment on the PA-38-112. The flight controls actuate the primary control surfaces through a cable system, and the controls are balanced for light operating forces.

The horizontal surface of the tail is a fixed stabilizer with a moveable elevator. A trim control wheel mounted between the seats operates the longitudinal trim function of the elevator (Figure 7-3). Rotation of the wheel forward gives nose down trim and rotation aft gives nose up trim. A trim position indicator is mounted adjacent to the trim control wheel.

The rudder is conventional in design and operation. A ground adjustable trim tab is attached to the trailing edge of the rudder.

The wing flaps are manually operated by the flap control lever located between the seats. The flaps are connected to the lever through a torque tube and push rods. The flaps can be set into three positions: fully retracted, 21 |

degrees extended, and fully (34 degrees) extended. To extend the flaps, pull the flap handle aft to the desired flap setting, hesitating momentarily as the ratchet locks into position. To retract the flaps, press the button on the end of the flap handle to disengage the ratchet and push the flap handle to the desired flap setting. When the flap setting is changed, there is an associated pitch change in the airplane. This pitch change can be corrected either by elevator trim or increased control wheel force.

7.11 ENGINE CONTROLS

Engine controls consist of a throttle control and a mixture control lever. These controls are located on the control quadrant on the lower center of the instrument panel (Figure 7-5) where they are accessible from both seats. The controls utilize teflon-lined control cables to reduce friction and binding.

The throttle lever is used to adjust engine RPM. The mixture control lever is used to adjust the air to fuel ratio. The engine is shut down by the placing of the mixture lever in the full lean position. For information on the leaning procedure, see the Avco-Lycoming Operator's Manual.

The friction adjustment wheel in the center of the control quadrant may be adjusted to increase or decrease the friction holding the throttle and mixture controls or to lock the controls in a selected position.

The carburetor heat control lever is located on the left of the control quadrant on the instrument panel. The control is placarded with two positions: "ON" (down), "OFF" (up).

7.13 FUEL SYSTEM

Fuel is stored in two sixteen gallon (15 gallons usable) fuel tanks, giving the airplane a total capacity of thirty-two U.S. gallons (30 gallons usable). The tanks are secured to the leading edge of each wing with rivets. When installed, a filler neck indicator aids in determining fuel remaining when the tanks are not full.

The fuel tank selector control (Figure 7-5) is located in the center of the engine control quadrant. The button on the selector cover must be depressed and held while the handle is moved to the OFF position. The button releases automatically when the handle is moved back to the ON position. A fuel quantity gauge for each fuel tank is located on either side of the fuel tank selector, each gauge on the same side as the corresponding fuel tank.

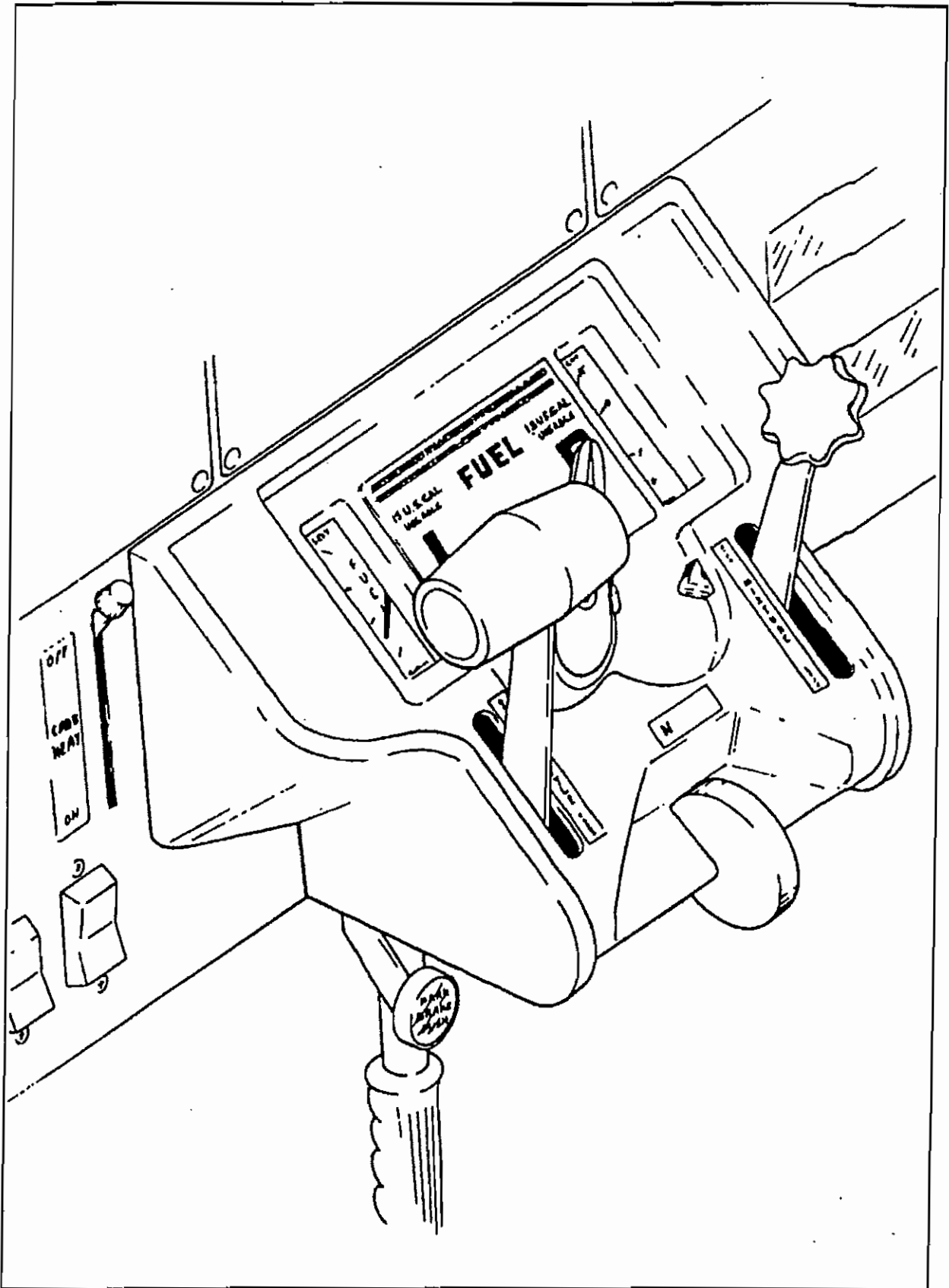

CONTROL QUADRANT FUEL SELECTOR
Figure 7-5

An auxiliary electric fuel pump is provided in case the engine-driven pump fails. The electric pump should be ON for all takeoffs and landings and when switching tanks. The fuel pump switch is located in the switch panel to the left of the throttle quadrant.

The fuel drains should be opened daily prior to the first flight to check for water or sediment. Each tank has an individual drain at the bottom inboard rear corner.

A fuel strainer, located on the lower left front of the fire wall, has a drain which is accessible from outside the left nose section. The strainer should also be drained before the first flight of the day. Refer to paragraph 8.21 for the complete fuel draining procedure.

The fuel pressure gauge is mounted in a gauge cluster located to the right of the control quadrant (refer to Figure 7-13).

An engine priming system is installed to facilitate starting. The primer pump is located to the lower right of the control quadrant.

7.15 ELECTRICAL SYSTEM

The electrical system includes a 14-volt, 60-ampere alternator, a voltage regulator, an over voltage relay, a battery contactor and a 12-volt, 25-ampere hour battery (Figure 7-9). The battery is entirely enclosed in a vented stainless steel box mounted in the engine compartment on the upper right forward side of the firewall. The voltage regulator and overvoltage relay are located on the right aft side of the firewall behind the instrument panel.

Electrical switches are located on the lower part of the instrument panel just left of center, and the circuit breakers are located on the lower right of the instrument panel. Each circuit breaker on the panel is of the push to reset type and is clearly marked as to its function and amperage. Circuit provisions have been included to handle the addition of various items of optional equipment (Figure 7-11). If a breaker pops, it should be allowed to cool for a couple of minutes before resetting the breaker.

Rheostat knobs to the left of the circuit breakers control the intensity of of instrument and radio lights. The master switch and magneto switch are on the lower left instrument panel below the left control wheel.

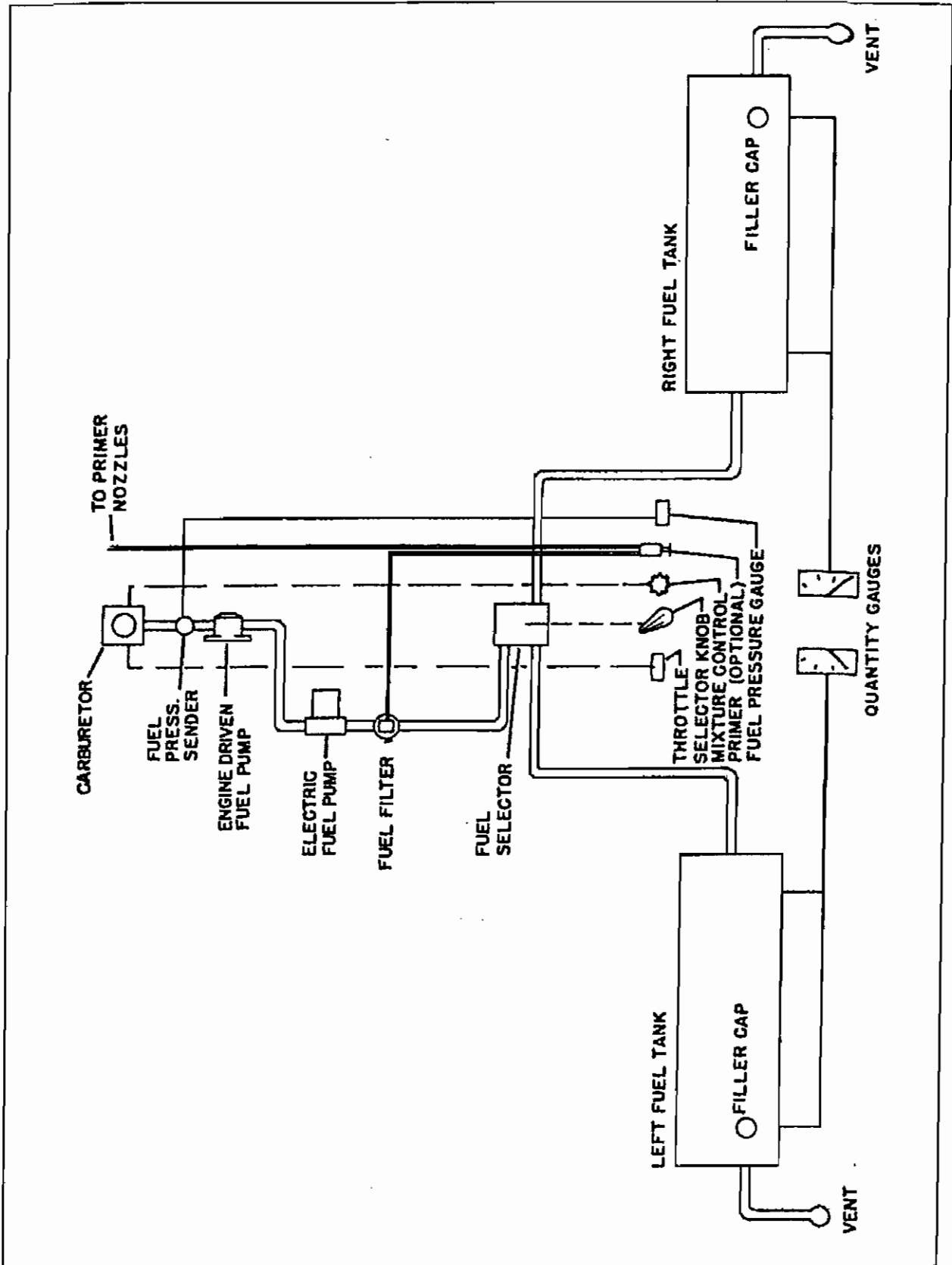

FUEL SYSTEM SCHEMATIC

Figure 7-7

Standard electrical accessories include a starter, a key lock ignition, an electric fuel pump, an audible stall warning, fuel gauges, an ammeter, and an alternator warning light.

The system provides for the addition of such optional accessories as interior and exterior lights, a heated pitot head, and communication and navigational equipment. The anti-collision and landing lights are controlled by rocker switches on the switch panel.

WARNING

Strobe lights should not be operating when flying through overcast and clouds since reflected light can produce spacial disorientation. Do not operate strobe lights in close proximity to ground, during takeoff and landing.

The master switch is a split rocker switch. One side of the switch is for the battery ("BAT") and the other is for the alternator ("ALT"). The words "master switch" as used in this handbook and unless otherwise indicated, refer to both the "BAT" and "ALT" switches, and they are to be depressed simultaneously to ON or OFF as directed.

The ammeter is mounted in the instrument cluster to the right of the engine control quadrant. The ammeter as installed indicates the electrical load on the alternator in amperes. With all the electrical equipment turned off and the master switch on, the ammeter will indicate the charging rate of the battery. As each electrical unit is switched on, the ammeter will indicate the total ampere draw of all the units including the battery. For example, the maximum continuous load for night flight with radios on is about 30 amperes. This 30 ampere value plus about 2 amperes for a fully charged battery will appear continuously under these flight conditions. The amount of current shown on the ammeter will tell immediately if the alternator system is operating normally, as the amount of current shown should equal the total amperage drawn by the electrical equipment which is operating.

The overvoltage relay protects the electronics equipment from a momentary overvoltage condition (approximately 16.5 volts and up) or a catastrophic regulator failure. If no output is indicated on the ammeter during flight, all unnecessary electrical equipment should be turned off to reduce the electrical load. The 5 ampere field circuit breaker should be checked and reset if open. If the breaker is not open, the "ALT" half of the

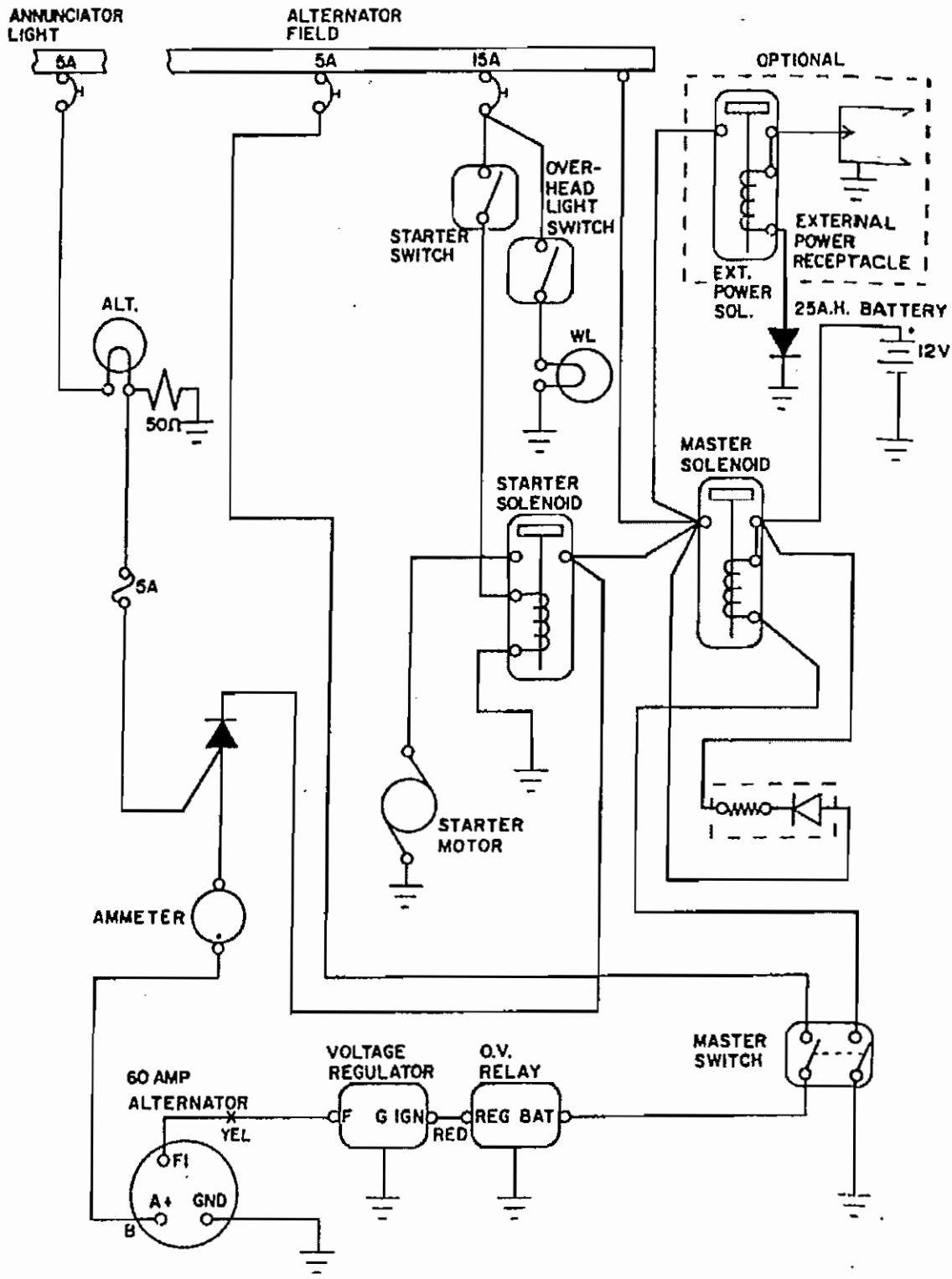

ALTERNATOR AND STARTER SCHEMATIC
S/N 38-78A0001 THRU 38-78A0800

Figure 7-9

THIS PAGE INTENTIONALLY LEFT BLANK

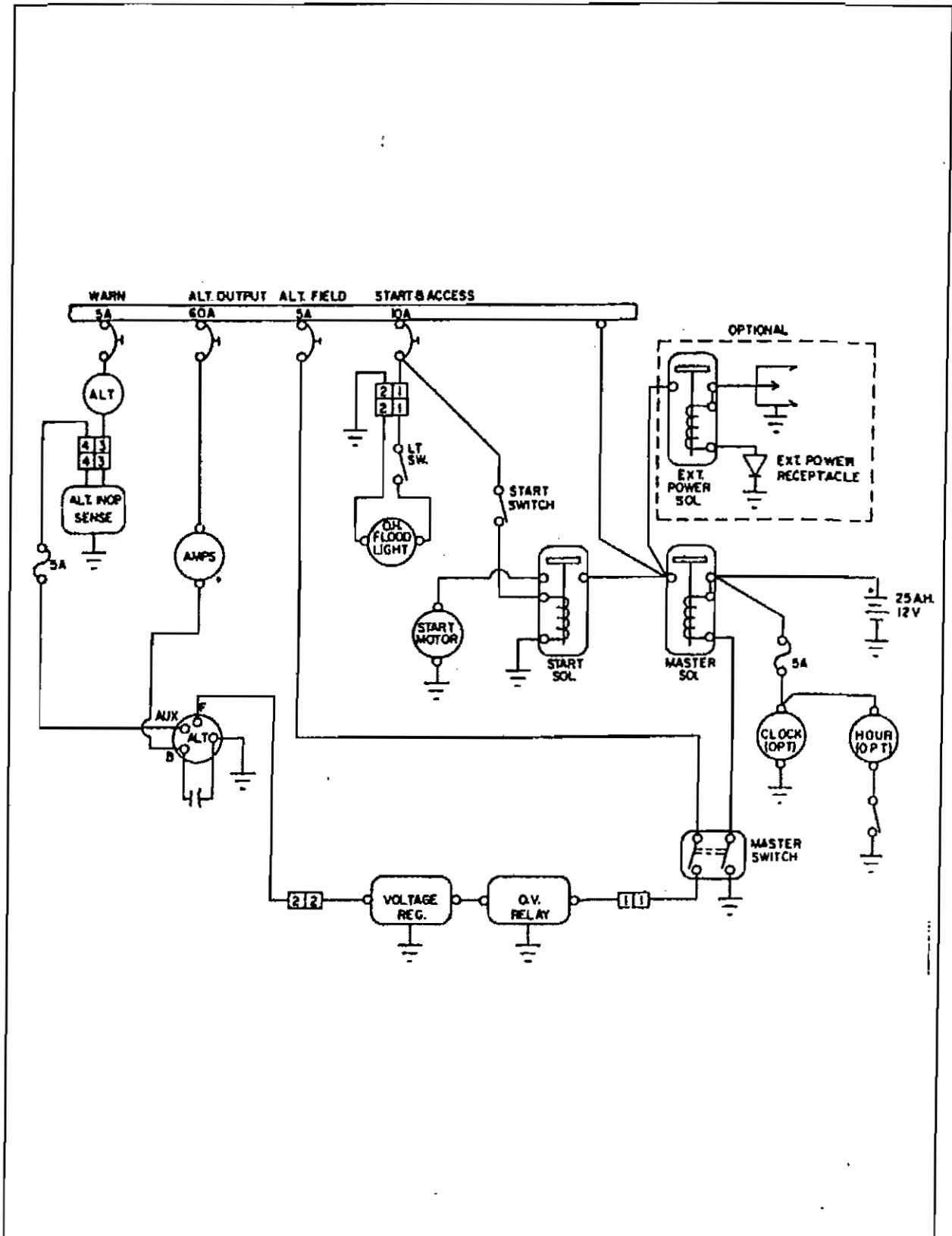

ALTERNATOR AND STARTER SCHEMATIC
S/N 38-78A0801 AND UP

Figure 7-9a

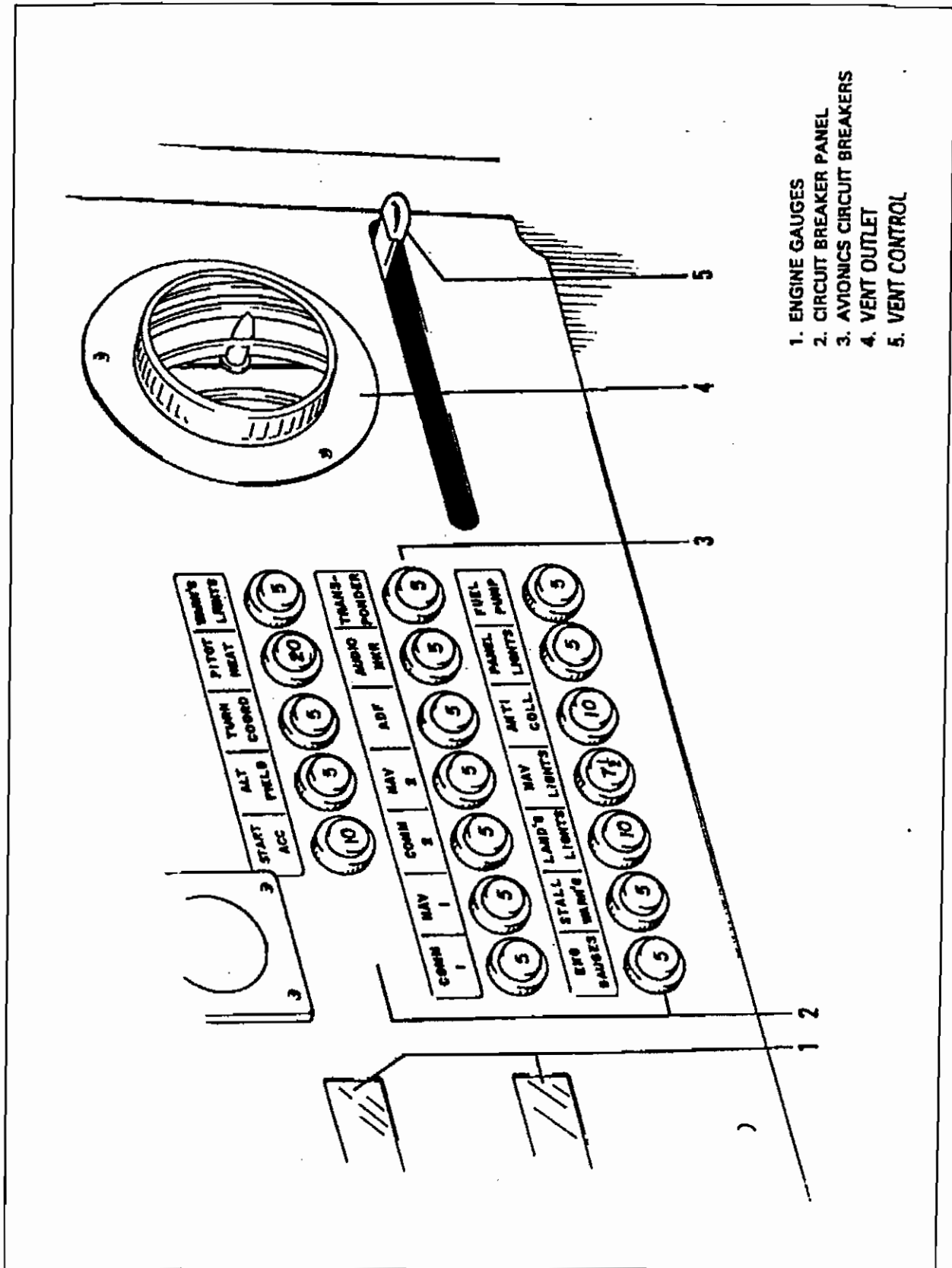

CIRCUIT BREAKER PANEL

Figure 7-11

master switch should be turned off for 1 second to reset the overvoltage relay. If the ammeter continues to indicate no output, electrical load should be maintained at the absolute minimum and the flight should be terminated as soon as practicable.

7.17 INSTRUMENT PANEL

The instrument panel (Figure 7-13) is designed to accommodate instruments and avionics equipment for VFR and IFR flight.

Radio equipment is mounted in the center and right instrument panel; flight instruments are mounted on the left. An engine instrument cluster in the lower instrument panel just right of the control quadrant includes a fuel pressure gauge, an ammeter, an oil temperature gauge and an oil pressure gauge. Fuel quantity indicators for each tank are mounted in the control quadrant on either side of the fuel selector. The tachometer is located to the left of the control quadrant. The alternator warning light is in the upper left instrument panel.

Circuit breakers are on the lower right of the instrument panel and electrical switches are just left of the control quadrant. Heater controls are to the left of the pilot's control wheel. Fresh air vents are located to the extreme left and right lower corners of the instrument panel.

Standard instruments include a compass, an airspeed indicator, a recording tachometer, an altimeter, the engine instrument cluster, the fuel quantity gauges and the alternator warning light. The magnetic compass is mounted in the center of the cockpit at the top of the windshield.

A variety of optional items are available for installation in the instrument panel. These options include a suction gauge on the upper left; an attitude gyro, a directional gyro, a true airspeed indicator, a vertical speed indicator and a turn coordinator in the flight instrument group; and an aircraft hour meter on the extreme right of the panel. The gyros are vacuum operated through the optional vacuum system, and the turn coordinator is electric. An optional primer system* is operated by a primer pump to the lower right of the control quadrant. An electric clock is available for installation in the upper left corner of the panel. The optional outside air temperature gauge is located in the overhead cockpit area.

*Standard on aircraft with serial nos. 38-79A0001 and up. Optional on earlier aircraft.

**SECTION 7
DESCRIPTION & OPERATION**

**PIPER AIRCRAFT CORPORATION
PA-38-112, TOMAHAWK**

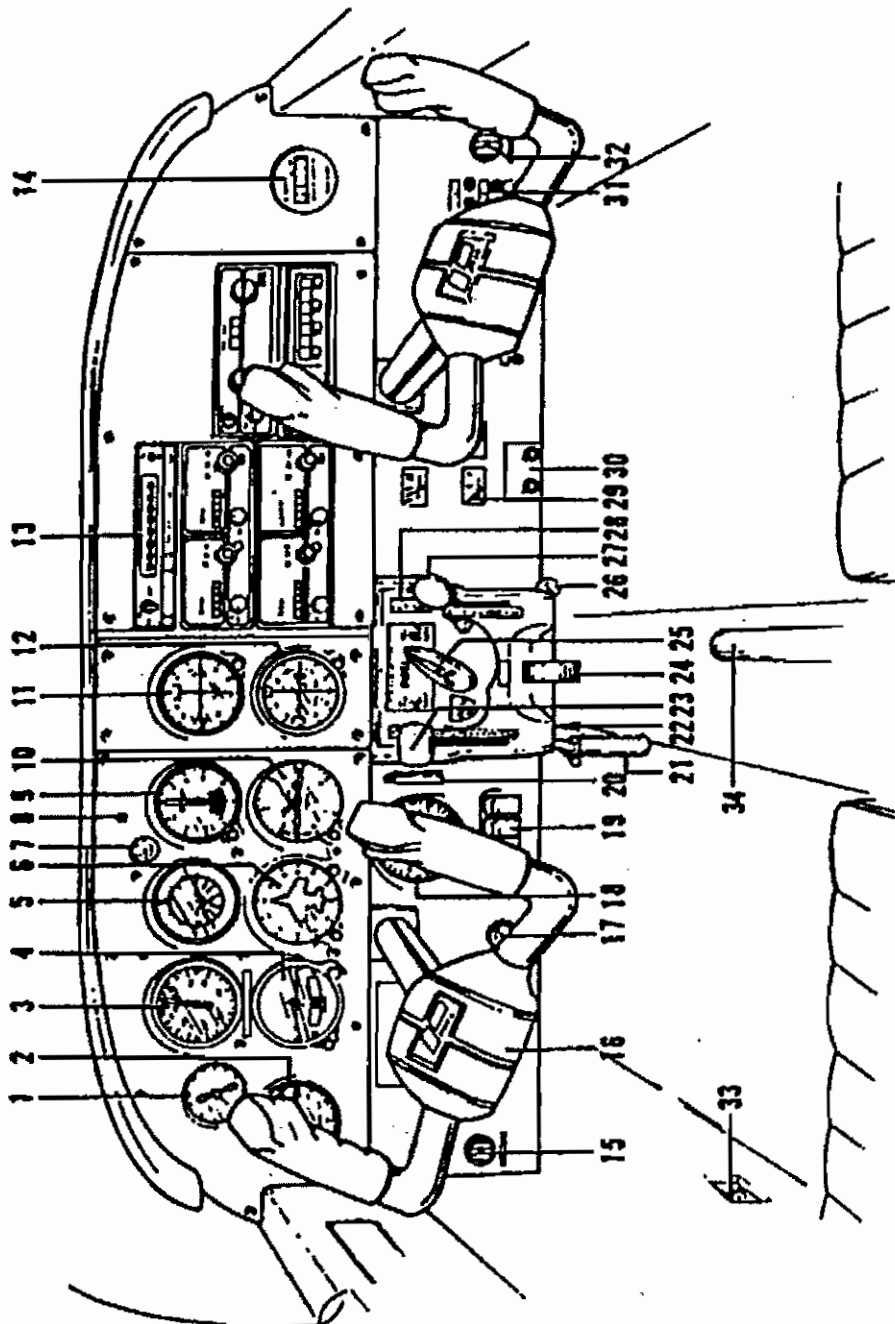

- | | | | |
|-----------------------------|-----------------------------|--|---|
| 1. CLOCK | 11. NAV 1 INDICATOR | 21. HAND BRAKE | 29. ENGINE INSTRUMENTS |
| 2. ADF INDICATOR | 12. NAV 2 INDICATOR | 22. ALTERNATE STATIC SOURCE (S/N 38-78A0001 THRU 38-81A0006) | 30. LIGHT DIMMER CONTROLS |
| 3. AIRSPEED INDICATOR | 13. AVONICS INSTALLATIONS | 23. THROTTLE | 31. CIRCUIT BREAKER PANEL |
| 4. TURN COORDINATOR | 14. HOURMETER | 24. FRICTION CONTROL | 32. CABIN HEAT |
| 5. ARTIFICIAL HORIZON | 15. CABIN VENT | 25. FUEL SELECTOR | 33. STATIC DRAIN (S/N 38-78A0001 THRU 38-81A0006) |
| 6. DIRECTIONAL GYRO | 16. CONTROL WHEEL | 26. PRIMER | ALTERNATE STATIC SOURCE AND DRAIN (S/N 38-81A0007 AND UP) |
| 7. VACUUM GAUGE | 17. MAGNETO SWITCH | 27. MIXTURE CONTROL | 34. FLAP CONTROL LEVER |
| 8. ALTERNATOR WARNING | 18. TACHOMETER | 28. FUEL QUANTITY GAUGES | |
| 9. ALTIMETER | 19. ELECTRICAL SWITCHES | | |
| 10. RATE OF CLIMB INDICATOR | 20. CARBURETOR HEAT CONTROL | | |

INSTRUMENT PANEL
Figure 7-13

7.19 VACUUM SYSTEM*

The vacuum system is designed to operate the air driven gyro instruments. This includes the directional and attitude gyros when installed. The system consists of an engine-driven vacuum pump, a vacuum regulator, a filter and the necessary plumbing.

The vacuum pump is a dry type pump. A shear drive protects the engine from damage. If the drive shears, the gyros will become inoperative.

A vacuum gauge mounted on the upper left instrument panel provides a pilot check for the system during operation. A decrease in pressure in a system that remained constant over an extended period may indicate a dirty filter, dirty screens, possibly a sticky vacuum regulator or leak in the system. Zero pressure would indicate a sheared pump drive, defective pump, possibly a defective gauge or collapsed line. In the event of any gauge variation from the norm, the pilot should have a mechanic check the system to prevent possible damage to the system components or eventual failure of the system.

A vacuum regulator is provided in the system to protect the gyros. The valve is set so the normal vacuum reads 5.0 + .1 inches of mercury, a setting which provides sufficient vacuum to operate all the gyros at their rated RPM. Higher settings will damage the gyros and with a low setting the gyros will be unreliable. The regulator is located behind the instrument panel. Vacuum pressure, even though set correctly, can read lower at very high altitude (above 12,000 ft), and at low engine RPM (usually on approach or during training maneuvers). This is normal and should not be considered a malfunction.

*Optional equipment

7.21 PITOT-STATIC SYSTEM

The pitot-static system supplies pressure to operate the airspeed indicator, the altimeter and the optional vertical speed indicator (Figure 7-15). Pitot pressure is picked up by a pitot head installed on the bottom of the left wing and static pressure is picked up by the pads on both sides of the aft fuselage.

A static valve located below the center instrument panel under the left side of the control quadrant provides an alternate static source for the system when opened.* A static drain and static valve located on the lower left side panel provides an alternate static source for the system when opened.** A correction card, indicating the change in altimeter reading and indicated airspeed when the alternate static source is in use, is mounted on the left side of the control quadrant cover. Static lines can be drained through a valve located inside an opening on the lower left side of the fuselage interior.

A heated pitot head which alleviates problems with icing and heavy rain is available as optional equipment. The switch for the heated pitot head is located on the electrical switch panel to the left of the control quadrant.

To prevent bugs and water entering the pitot hole, a cover should be placed over the pitot head while the airplane is moored. A partially or completely blocked pitot head will give erratic or zero readings on the instruments.

NOTE

During preflight, check to make sure the pitot cover is removed.

*S/N 38-78A0001 thru 38-81A0006

**S/N 38-78A0001 thru 38-81A0006, and S/N 38-81A0007 and up.

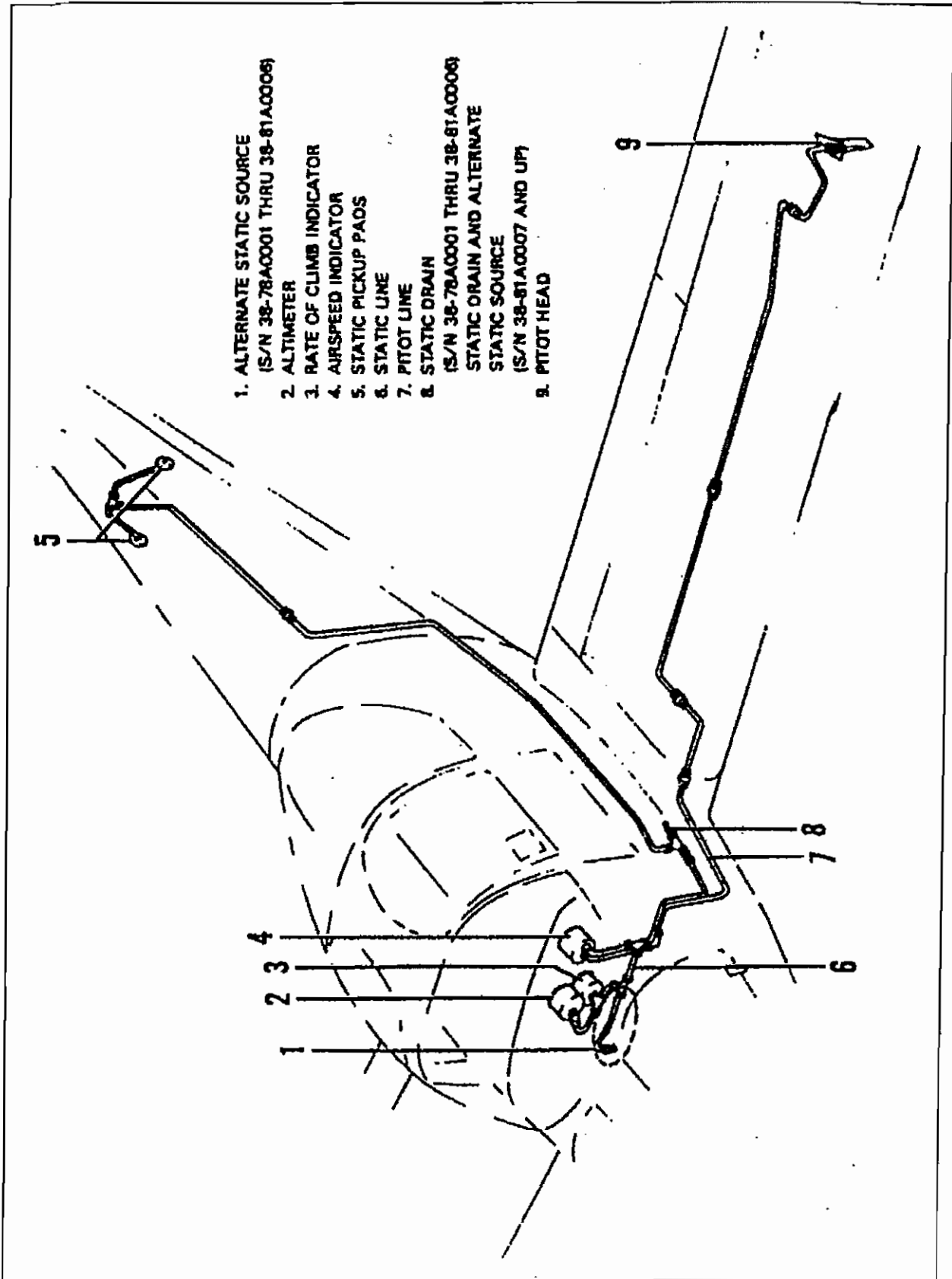

PITOT-STATIC SYSTEM

Figure 7-15

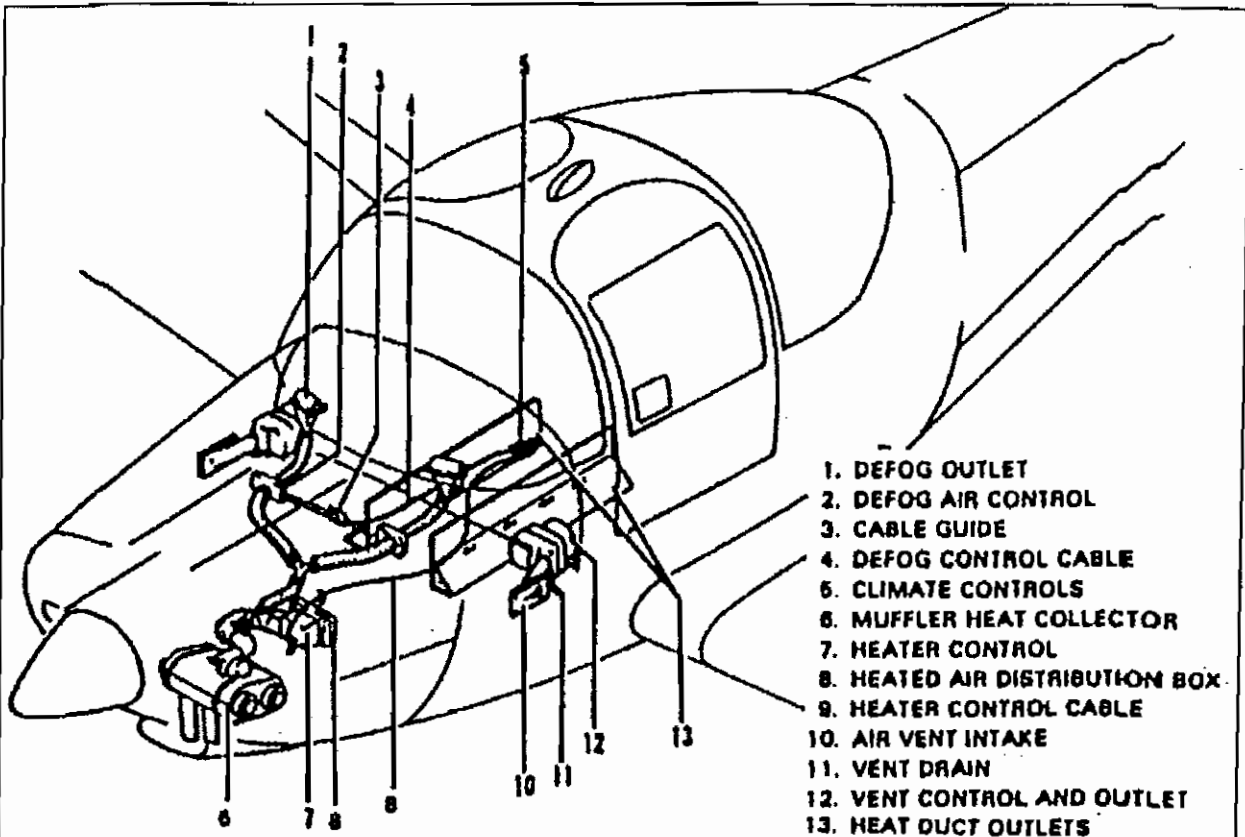

S/N 38-78A0001 THRU 38-80A0198

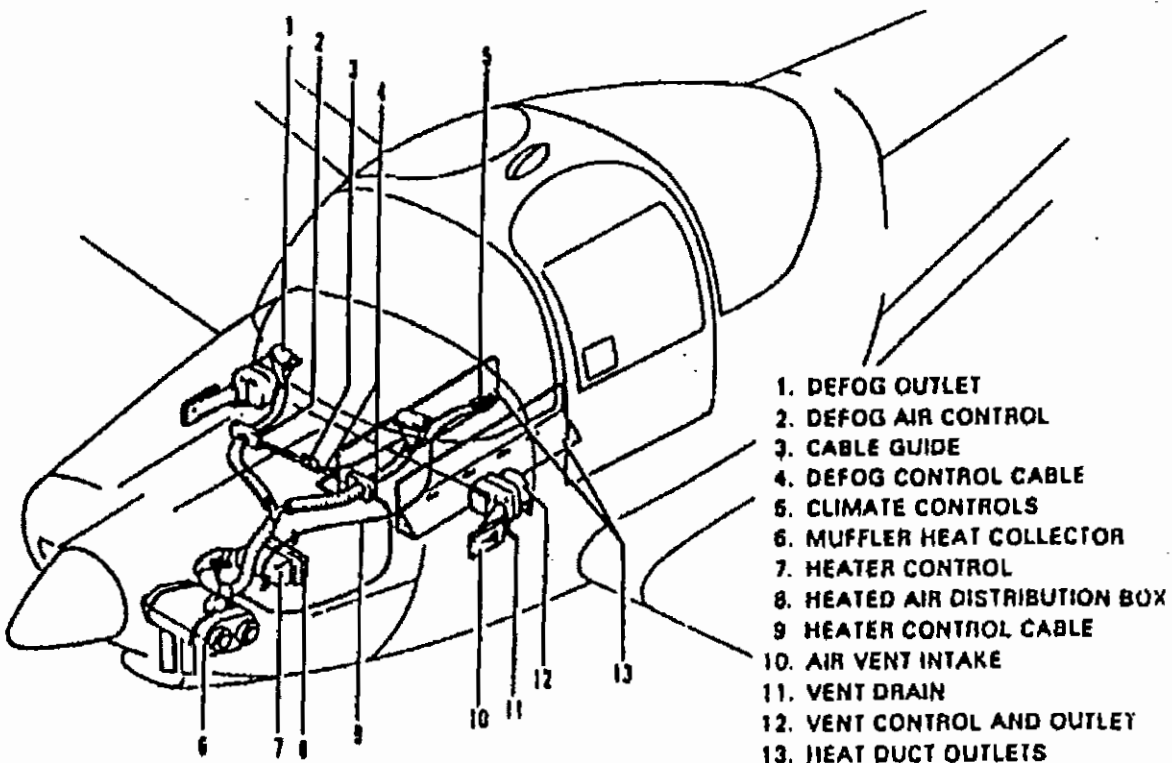

S/N 38-81A0001 AND UP

HEATING AND VENTILATING SYSTEM

Figure 7-17

7.23 HEATING AND VENTILATING SYSTEM

Heat for the cabin interior and the defroster system (Figure 7-17) is provided by a shroud attached to the mufflers. Fumes in the cockpit could be an indication of an exhaust leak; therefore, if unusual odors are detected, the heater should be turned off and the system inspected before further operation. The amount of heat and the routing of airflow can be regulated with the controls located on the left instrument panel. Heater air may be directed to the outlets in the lower firewall below the instrument panel and the ducts mounted along the center tunnel on the right and left cockpit floor or to defroster outlets at the base of the windshield.

Fresh air intakes are located on each side of the fuselage in the area aft of the engine cowling. Adjustable outlets on each lower corner of the instrument panel allow fresh air to be admitted and directed. An on-off lever is mounted below each fresh air outlet.

7.25 CABIN FEATURES

For comfort and visibility, the seats are adjustable forward and aft. The seat tracks are inclined and provide automatic vertical adjustment; the seat is raised in the forward position and lowered in the aft position. The seat adjustment levers are on the centers of the seat frames just below the forward edges of the cushions. Both seat backs tilt forward to allow access to the baggage compartment.

Safety belts are standard equipment on both seats. Inertia reels for the shoulder straps are offered as optional equipment. For normal body movements, the inertia reel extends or retracts as required, but during sudden forward movement, the reel locks in place to prevent the strap from extending.

Standard interior equipment includes a pilot storm window, door pulls with integral armrests, a glare shield, an ash tray, and a carpeted floor. The microphone and earphone jacks are between the seats on the center console. A tinted rear window is also standard equipment. Standard equipment on later model aircraft incorporates a glare shield with hand holds and side panel map pockets.

Each cabin door has an interior latch below the side window. The latch is engaged when the handle is in the down position. The overhead latch in the center of the cockpit secures both doors (Figure 7-19) Before flight, the

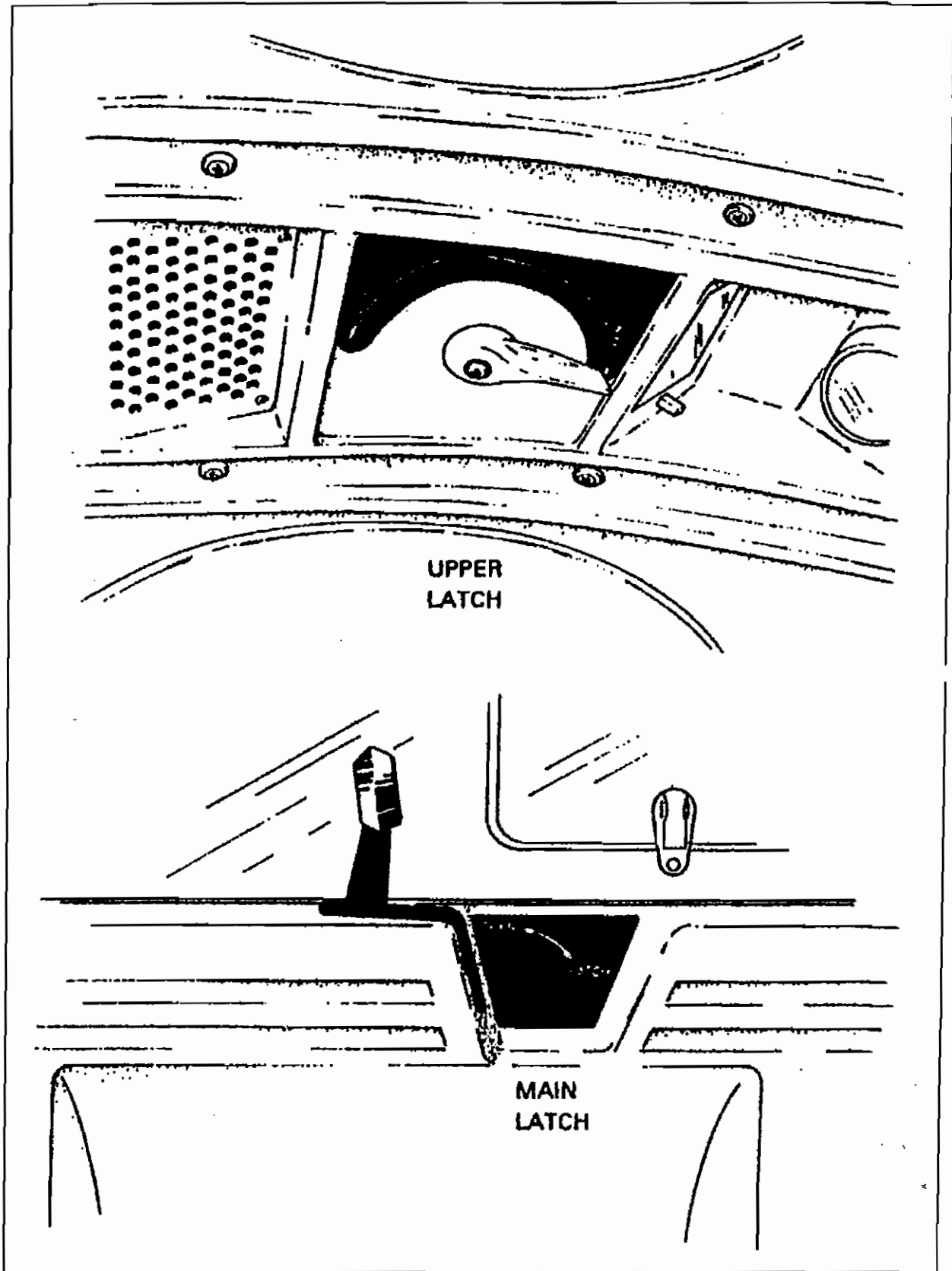

UPPER AND MAIN DOOR LATCHES

Figure 7-19

latches on both doors plus the overhead latch should be secured in the latched position. A key lock is installed on the exterior overhead latch.

Optional equipment available for the cabin includes a tinted windshield and side windows, sun visors and entrance steps.

7.27 BAGGAGE AREA

A 20 cubic foot baggage area, located behind the seats, is accessible from the cabin. Maximum capacity is 100 pounds. Tie-down straps are available and they should be used at all times.

NOTE

It is the pilot's responsibility to be sure when the baggage is loaded that the aircraft C.G. falls within the allowable C.G. range. (See Weight and Balance Section.)

7.29 STALL WARNING

An approaching stall is indicated by an audible alarm located behind the instrument panel. The indicator activates at between five and ten knots above stall speed.

7.31 FINISH

All exterior surfaces are primed with etching primer and finished with acrylic lacquer. To keep the finish attractive, economy size spray cans of touch-up paint are available from Piper Dealers.

7.33 EMERGENCY LOCATOR TRANSMITTER*

The Emergency Locator Transmitter (ELT), when installed, is enclosed under a hinged cover on the aft portion of the cockpit center console. The unit meets the requirements of FAR 91.52. The transmitter operates on a self-contained battery.

*Optional equipment

**SECTION 7
DESCRIPTION & OPERATION**

**PIPER AIRCRAFT CORPORATION
PA-38-112, TOMAHAWK**

A battery replacement date is marked on the transmitter label. To comply with FAA regulations, the battery must be replaced on or before this date. The battery must also be replaced if the transmitter has been used in an emergency situation or if the accumulated test time exceeds one hour, or if the unit has been inadvertently activated for an undetermined time period.

When installed in the airplane, the ELT transmits through the antenna mounted on the fuselage. The unit is also equipped with an integral portable antenna to allow the locator to be removed from the airplane in an emergency and used as a portable signal transmitter.

The locator should be checked during the preflight ground check to make sure that it has not been accidentally activated. Check by tuning a radio receiver to 121.5 MHz. If there is an oscillating sound, the locator may have been activated and should be turned off immediately. Rearm the unit and then recheck.

NOTE

If for any reason a test transmission is necessary, the test transmission should be conducted only in the first five minutes of any hour and limited to three audio sweeps. If tests must be made at any other time the tests should be coordinated with the nearest FAA tower or flight service station.

NARCO ELT 10 OPERATION

On the unit is a switch placarded "ON," "OFF," and "ARM." the "ARM" position allows the unit to be set to the automatic mode so that it will transmit only after activation by impact and will continue to transmit until the battery is drained to depletion or until the switch is manually moved to the "OFF" position. The "ARM" position should be selected whenever the unit is in the airplane. The "ON" position is provided so the unit can be used as a portable transmitter or in the event the automatic feature was not triggered by impact or to periodically test the function of the transmitter. The "OFF" position should be selected while changing the battery or to discontinue transmission after the unit has been activated.

A button labeled "RESET" is located above the selector switch. To rearm the unit after it has been turned off or after it has been activated, the "RESET" button should be pressed in after the selector switch has been placed in the "ARM" position. This will end transmission and rearm the unit.

CCC CIR 11 OPERATION

On the unit itself is a three position selector switch placarded "OFF," "ARM" and "ON." The "ARM" position is provided to set the unit to the automatic position so that it will transmit only after impact and will continue to transmit until the battery is drained to depletion or until the switch is manually moved to the "OFF" position. The "ARM" position should be selected whenever the unit is in the airplane. The "ON" position is provided so the unit can be used as a portable transmitter or in the event the automatic feature was not triggered by impact or to periodically test the function of the transmitter.

Select the "OFF" position when changing the battery, when rearming the unit if it has been activated for any reason, or to discontinue transmission.

NOTE

If the switch has been placed in the "ON" position for any reason, the "OFF" position has to be selected before selecting "ARM". If "ARM" is selected directly from the "ON" position, the unit will continue to transmit in the "ARM" position.

7.35 SERIAL NUMBER PLATE

The manufacturer's name plate is located on the underside of the aft fuselage, forward of the tail skid. The serial number should always be used in referring to the airplane in service and warranty matters.

7.37 FIRE EXTINGUISHER (PORTABLE)*

A portable fire extinguisher is mounted to the floor of the baggage compartment directly behind the flight control console between the seats. The extinguisher is suitable for use on liquid or electrical fires. It is operated by aiming the nozzle at the base of the fire and squeezing the trigger grip. Releasing the trigger automatically stops further discharge of the extinguishing agent. Read the instructions on the nameplate and become familiar with the unit before an emergency situation. The dry powder type extinguisher is fully discharged in about 10 seconds, while the Halon 1211 type is discharged in 15 to 20 seconds.

WARNING

The concentrated agent from extinguishers using Halon 1211 or the by-products when applied to a fire are toxic when inhaled. Ventilate the cabin as soon as possible after fire is extinguished to remove smoke or fumes.

7.39 INTERCOM SYSTEM*

An optional intercom system is available. This system provides for normal conversation between pilot and passenger. The system consists of a headset with a boom microphone, with volume and tone controls mounted in the instrument panel.

The communication between the pilot and the passenger is voice activated when the system is turned on.

Radio communication between the pilot and/or the passenger and a radio facility is initiated through push-to-transmit switches mounted on the control wheels. A priority override feature allows either the pilot or passenger to preempt the conversation between pilot and passenger to respond to radio communication. Voice communication from a radio facility is audible through the headset.

*Optional equipment

TABLE OF CONTENTS

SECTION 8

AIRPLANE HANDLING, SERVICING AND MAINTENANCE

Paragraph No.		Page No.
8.1	General.....	8-1
8.3	Airplane Inspection Periods.....	8-2
8.5	Preventive Maintenance.....	8-3
8.7	Airplane Alterations.....	8-4
8.9	Ground Handling.....	8-5
8.11	Engine Air Filter.....	8-7
8.13	Brake Service.....	8-8
8.15	Landing Gear Service.....	8-8
8.17	Propeller Service.....	8-11
8.19	Oil Requirements.....	8-11
8.21	Fuel System.....	8-12
8.23	Tire Inflation.....	8-14
8.25	Battery Service.....	8-14
8.27	Cleaning.....	8-15
8.29	Lubrication.....	8-18
8.31	Winterization.....	8-18

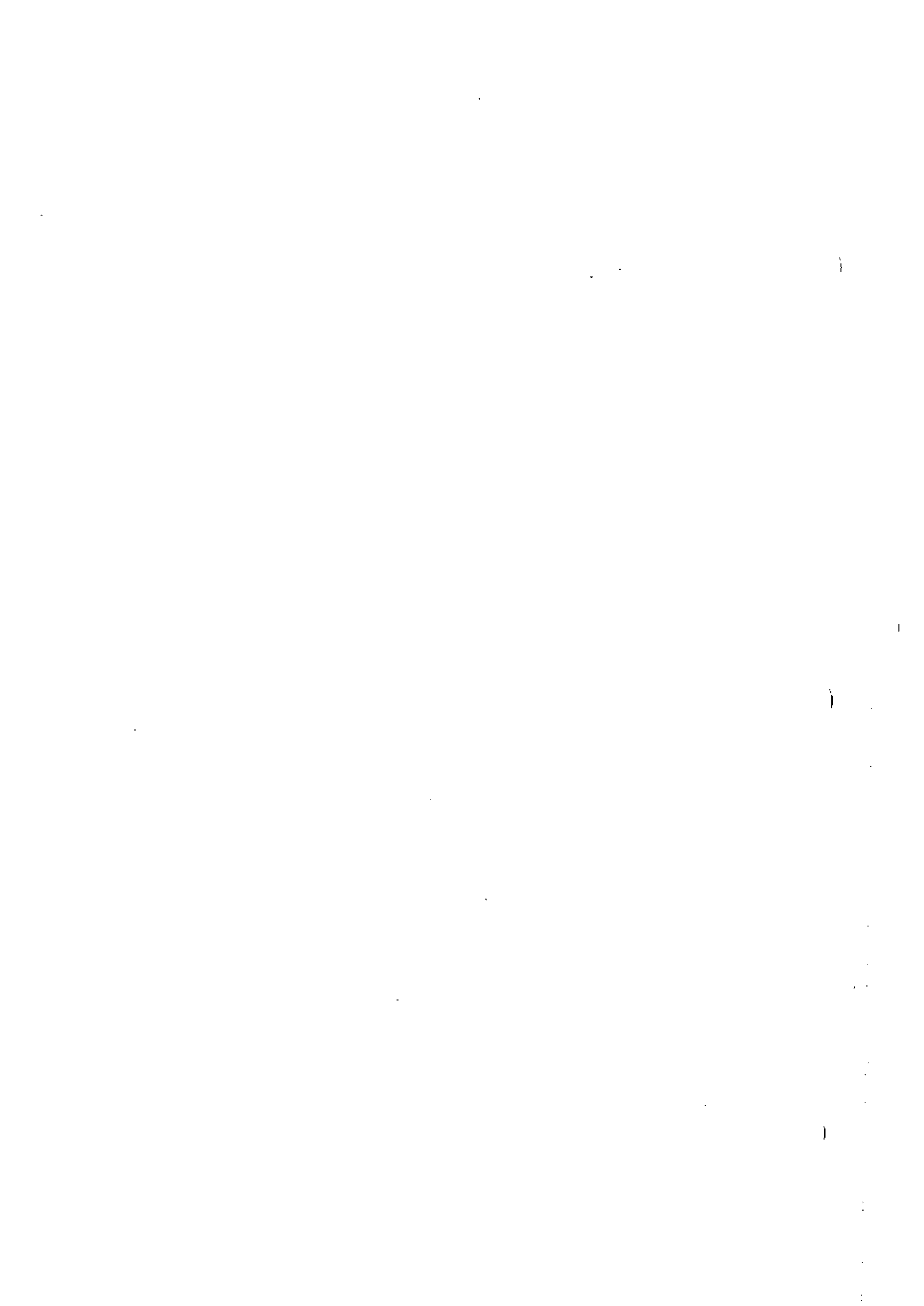

SECTION 8

AIRPLANE HANDLING, SERVICING, AND MAINTENANCE

8.1 GENERAL

This section provides guidelines relating to the handling, servicing, and maintenance of the Tomahawk. For complete maintenance instructions, refer to the PA-38-112 Maintenance Manual.

Every owner should stay in close contact with an authorized Piper Service Center or Piper's Customer Services Department to obtain the latest information pertaining to their airplane, and to avail themselves of Piper Aircraft's support systems.

Piper Aircraft Corporation takes a continuing interest in having owners get the most efficient use from their airplane and keeping it in the best mechanical condition. Consequently, Piper Aircraft, from time to time, issues service releases including Service Bulletins, Service Letters, Service Spares Letters, and others relating to the airplane.

Piper Service Bulletins are of special importance and Piper considers compliance mandatory. These are sent directly to the latest FAA-registered owners in the United States (U.S.) and Piper Service Centers worldwide. Depending on the nature of the release, material and labor allowances may apply. This information is provided to all authorized Piper Service Centers.

Service Letters deal with product improvements and servicing techniques pertaining to the airplane. They are sent to Piper Service Centers and, if necessary, to the latest FAA-registered owners in the U.S. Owners should give careful attention to Service Letter information.

Service Spares Letters offer improved parts, kits, and optional equipment which were not available originally, and which may be of interest to the owner.

Piper Aircraft Corporation offers a subscription service for Service Bulletins, Service Letters, and Service Spares Letters. This service is available to interested persons such as owners, pilots, and mechanics at a nominal fee and may be obtained through an authorized Piper Service Center or Piper's Customer Services Department.

Maintenance manuals, parts catalogs, and revisions to both, are available from Piper Service Centers or Piper's Customer Services Department.

Any correspondence regarding the airplane should include the airplane model and serial number to ensure proper response.

8.3 AIRPLANE INSPECTION PERIODS

Piper Aircraft Corporation has developed inspection items and required inspection intervals for the PA-38-112 (see PA-38-112 Maintenance and Inspection Manuals). The PA-38-112 Inspection Manual contains appropriate forms, and all inspection procedures should be complied with by a properly trained, knowledgeable, and qualified mechanic at an authorized Piper Service Center or a reputable repair shop. Piper Aircraft Corporation cannot accept responsibility for the continued airworthiness of any aircraft not maintained to these standards, and/or not brought into compliance with applicable Service Bulletins issued by Piper Aircraft Corporation, instructions issued by the engine, propeller, or accessory manufacturers, or Airworthiness Directives issued by the FAA.

A programmed Inspection, approved by the Federal Aviation Administration (FAA), is also available to the owner. This involves routine and detailed inspections to allow maximum utilization of the airplane. Maintenance inspection costs are reduced, and the maximum standard of continued airworthiness is maintained. Complete details are available from Piper Aircraft Corporation.

In addition, but in conjunction with the above, the FAA requires periodic inspections on all aircraft to keep the Airworthiness Certificate in effect. The owner is responsible for assuring compliance with these inspection requirements and for maintaining proper documentation in logbooks and/or maintenance records.

A spectrographic analysis of the engine oil is available from several sources. This inspection, if performed properly, provides a good check of the internal condition of the engine. To be accurate, induction air filters must be cleaned or changed regularly, and oil samples must be taken and sent in at regular intervals.

8.5 PREVENTIVE MAINTENANCE

The holder of a Pilot Certificate issued under FAR Part 61 may perform certain preventive maintenance described in FAR Part 43. This maintenance may be performed only on an aircraft which the pilot owns or operates and which is not used to carry persons or property for hire, except as provided in applicable FAR's. Although such maintenance is allowed by law, each individual should make a self-analysis as to whether he has the ability to perform the work.

All other maintenance required on the airplane should be accomplished by appropriately licensed personnel.

If maintenance is accomplished, an entry must be made in the appropriate logbook. The entry should contain:

- (a) The date the work was accomplished.
- (b) Description of the work.
- (c) Number of hours on the aircraft.
- (d) The certificate number of pilot performing the work.
- (e) Signature of the individual doing the work.

8.7 AIRPLANE ALTERATIONS

If the owner desires to have the aircraft modified, FAA approval must be obtained for the alteration. Major alterations accomplished in accordance with Advisory Circular 43.13-2, when performed by an A & P mechanic, may be approved by the local FAA office. Major alterations to the basic airframe or systems not covered by AC 43.13-2 require a Supplemental Type Certificate.

The owner or pilot is required to ascertain that the following Aircraft Papers are in order and in the aircraft.

- (a) To be displayed in the aircraft at all times:
 - (1) Aircraft Airworthiness Certificate Form FAA-8 100-2.
 - (2) Aircraft Registration Certificate Form FAA-8050-3.
 - (3) Aircraft Radio Station License if transmitters are installed.

- (b) To be carried in the aircraft at all times:
 - (1) Pilot's Operating Handbook.
 - (2) Weight and Balance data plus a copy of the latest Repair and Alteration Form FAA-337, if applicable.
 - (3) Aircraft equipment list.

Although the aircraft and engine logbooks are not required to be in the aircraft, they should be made available upon request. Logbooks should be complete and up to date. Good records will reduce maintenance cost by giving the mechanic information about what has or has not been accomplished.

8.9 GROUND HANDLING

(a) Towing

The airplane may be moved on the ground by the use of the nose wheel steering bar* that is stowed in the baggage compartment or by power equipment that will not damage or excessively strain the nose gear steering assembly. Towing lugs are incorporated as part of the nose gear fork.

CAUTIONS

When towing with power equipment, do not turn the nose gear beyond its steering radius in either direction, as this will result in damage to the nose gear and steering mechanism.

Do not tow the airplane when the controls are secured. Do not push or pull on the propeller or control surfaces.

(b) Taxiing

Before attempting to taxi the airplane, ground personnel should be instructed and approved by a qualified person authorized by the owner. Engine starting and shut-down procedures as well as taxi techniques should be covered. When it is ascertained that the propeller back blast and taxi areas are clear, power should be applied to start the taxi roll, and the following checks should be performed:

- (1) Taxi a few feet forward and apply the brakes to determine their effectiveness.
- (2) While taxiing, make slight turns to ascertain the effectiveness of the steering.
- (3) Observe wing clearance when taxiing near buildings or other stationary objects. If possible, station an observer outside the airplane.
- (4) When taxiing over uneven ground, avoid holes and ruts.
- (5) Do not operate the engine at high RPM when running up or taxiing over ground containing loose stones, gravel, or any loose material that may cause damage to the propeller blades.

*Optional equipment

(c) Parking

When parking the airplane, be sure that it is sufficiently protected from adverse weather conditions and that it presents no danger to other aircraft. When parking the airplane for any length of time or overnight, it is suggested that it be moored securely.

- (1) To park the airplane, head it into the wind if possible.
- (2) Set the parking brake by pulling back on the brake lever and depressing the button on the handle. To release the parking brake, pull back on the handle until the catch disengages; then allow the handle to swing forward.

CAUTION

Brakes should not be set when overheated or during cold weather when accumulated moisture may freeze a brake.

- (3) Aileron and elevator controls should be secured with the front seat belt and chocks used to properly block the wheels.

(d) Mooring

The airplane should be moored for immovability, security and protection. The following procedures should be used for the proper mooring of the airplane:

- (1) Head the airplane into the wind if possible.
- (2) Retract the flaps.
- (3) Immobilize the ailerons and elevators by looping the seat belt through the control wheel and pulling it snug.
- (4) Block the wheels.
- (5) Secure tie-down ropes to the wing tie-down rings and to the tail skid at approximately 45 degree angles to the ground. When using rope of non-synthetic material, leave sufficient slack to avoid damage to the airplane should the ropes contract.

CAUTION

Use bowline knots, square knots or locked slip knots. Do not use plain slip knots.

NOTE

Additional preparations for high winds include using tie-down ropes from the nose landing gear fork and securing the rudder.

- (6) Install a pitot head cover if available. Be sure to remove the pitot head cover before flight.
- (7) Cabin doors should be locked when the airplane is unattended.

8.11 ENGINE AIR FILTER

The dry type induction air filter must be inspected and cleaned at least once every 50 hours, and more often, even daily, when operating in dusty conditions. The filter is disposable and inexpensive and a spare should always be kept on hand for a rapid replacement.

(a) Removal of Engine Air Filter

The filter is located in the lower front of the engine compartment and is accessible through the chin scoop intake with the cowling intact. It may be removed by the following procedure:

- (1) Loosen the 1/4-turn attachment screws securing the filter. The top screws are accessible through the intake opening, the bottom screws through the two ports on the underside of the scoop.
- (2) Remove the filter through the intake opening.

(b) Cleaning Engine Air Filter

- (1) Tap the filter gently to remove loose dirt particles, being careful not to damage the filter. DO NOT wash the filter in any liquid. DO NOT attempt to blow out dirt with compressed air.
- (2) If the filter is excessively dirty or shows any damage, discard it and replace it immediately.
- (3) Wipe the filter housing with a clean cloth.

(c) Installation of Engine Air Filter

After cleaning or when replacing the filter, install the filter in the reverse order of removal.

8.13 BRAKE SERVICE

The brake system (Figure 8-1) is filled with Unavis No. 40 or MIL-H-5606 (petroleum base) hydraulic brake fluid. The fluid level should be checked periodically or at every 50 hour inspection and replenished when necessary. The brake reservoir is located on the fire wall in the engine compartment. If the entire system must be refilled, fill with fluid under pressure from the brake end of the system. This will eliminate air from the system.

No adjustment of the brake clearances is necessary. If after extended service brake blocks become excessively worn, they should be replaced with new segments.

8.15 LANDING GEAR SERVICE

The landing gears use 5.00 x 5 or optional 6.00 x 6 wheel assemblies*. All three tires are four ply rating, type III tires with tubes. (Refer to paragraph 8.23.)

CAUTION

Proper tire inflation must be maintained to prevent high sensitivity of the nose wheel steering during takeoffs and landings.

Wheels are removed by taking off the hub cap, cotter pin, axle nut, and the bolts holding the brake segment in place. Mark tire and wheel for reinstallation; then dismount by deflating the tire, removing the through-bolts from the wheel and separating the wheel halves.

The nose gear oleo should be serviced according to the instructions on the unit. The oleo should be extended under normal static load until 3 inches of oleo piston tube is exposed. Should the strut exposure be below that required, it should be determined whether air or oil is required by first raising the airplane on jacks. Depress the valve core to allow air to escape from the strut housing chamber. Remove the filler plug and slowly raise the strut to full compression. If the strut has sufficient fluid, it will be visible up to the bottom of the filler plug hole and will then require only proper inflation.

*6.00 x 6 wheel assemblies are standard on aircraft with serial nos. 38-81A0001 and up. Optional on earlier aircraft.

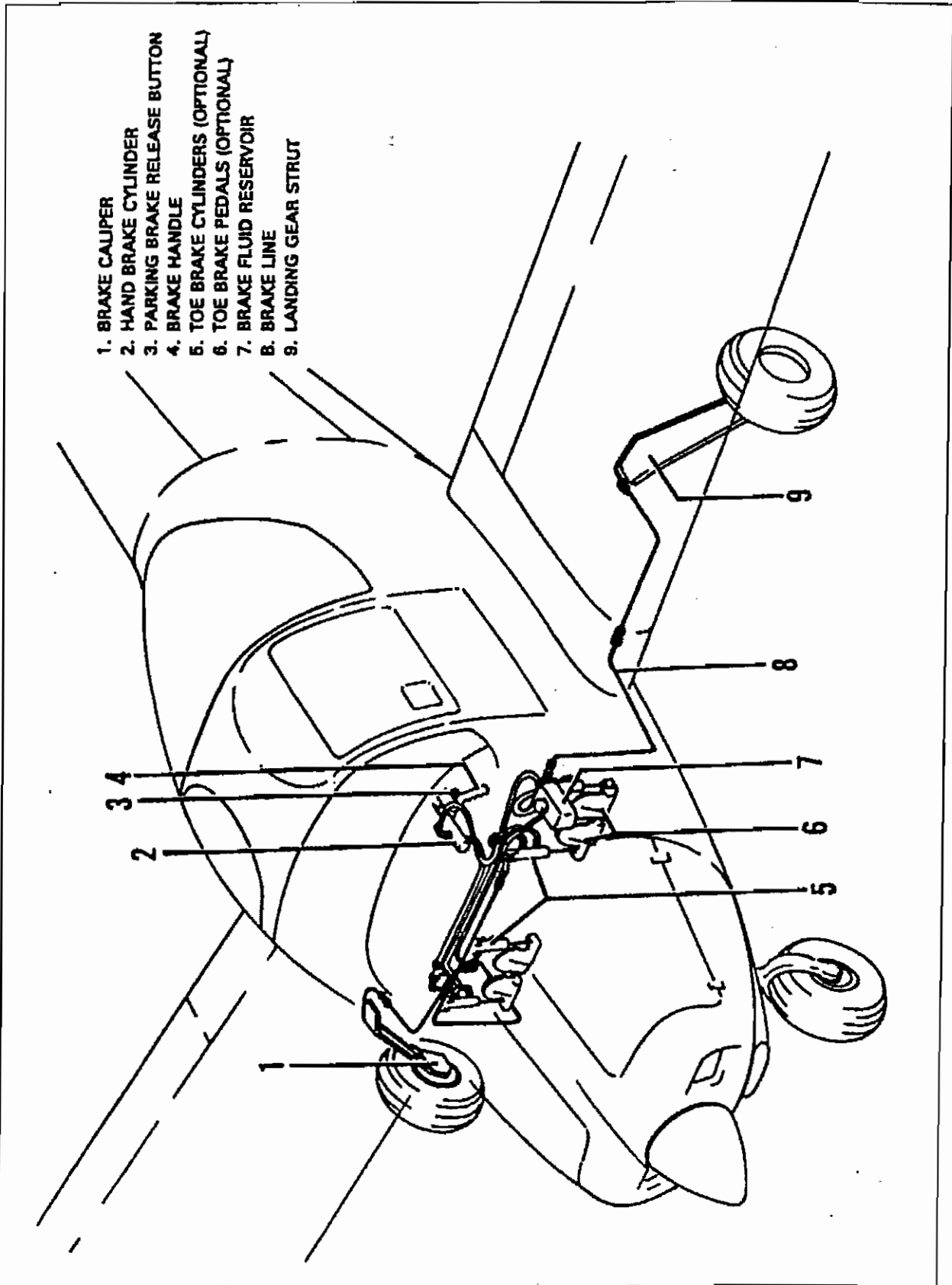

BRAKE SYSTEM

Figure 8-1

Should fluid be below the bottom of the filler plug hole, fluid should be added. Replace the plug with the valve core removed; attach a clear plastic hose to the valve stem of the filler plug and submerge the other end in a container of Univis No. 40 hydraulic fluid. Fully compress and extend the strut several times, thus drawing fluid from the container and expelling air from the strut chamber. When air bubbles cease to flow through the hose, compress the strut fully and check fluid level. Reinstall the valve core and filler plug.

With fluid in the strut housing at the correct level, attach a strut pump to the air valve and with the airplane on the ground, inflate the oleo strut to the correct height.

In jacking the aircraft for landing gear or other service, two hydraulic jacks and a tail stand should be used. At least 250 pounds of ballast should be placed on the base of the tail stand before the airplane is jacked up. The hydraulic jacks should be placed under the jack points on the bottom of the wing and the airplane jacked up until the tail skid is at the right height to attach the tail stand. After the tail stand is attached and the ballast added, jacking may be continued until the airplane is at the height desired.

The push-pull steering rods from the rudder pedals to the nose gear steering arm are adjusted at either end by turning the threaded rod end bearings in or out. Adjustment is normally accomplished at the forward end of the rods and should be done in such a way that the nose wheel is in line with the fore and aft axis of the plane when the rudder pedals and rudder are centered. Alignment of the nose wheel can be checked by pushing the airplane back and forth with the rudder centered to determine that the plane follows a perfectly straight line. The turning arc of the nose wheel is $30.0^\circ + 2^\circ$ in either direction and is limited by stops on the bottom of the forging.

The stops on the bottom of the nose gear are also the stops for the rudder pedal arms and should be carefully adjusted so that the pedal arms contact the stops just after the rudder hits its stops. This guarantees that the rudder will be allowed to move through its full travel.

8.17 PROPELLER SERVICE

The spinner and backing plate should be frequently cleaned and inspected for cracks. Before each flight the propeller should be inspected for nicks, scratches, and corrosion. If found, they should be repaired as soon as possible by a rated mechanic, since a nick or scratch causes an area of increased stress which can lead to serious cracks or the loss of a propeller tip. The back face of the blades should be painted when necessary with flat black paint to retard glare. To prevent corrosion, the surface should be cleaned and waxed periodically.

8.19 OIL REQUIREMENTS

The oil capacity of the Lycoming O-235-L2C or O-235-L2A engine is 6 quarts, and the minimum safe quantity is 2 quarts. It is recommended that the oil be changed every 50 hours and sooner under unfavorable operating conditions. Intervals between oil changes can be increased as much as 100% on engines equipped with full flow (cartridge type) oil filters, provided the element is replaced each 50 hours of operation and the specified octane fuel is used. Should fuel other than the specified octane rating for the power plant be used, refer to the latest issue of Lycoming Service Letter No. L185 and Lycoming Service Instruction No. 1014 for additional information and recommended service procedures. The following grades of aviation engine oil are recommended for the specified temperatures:

Average Ambient Air Temperature For Starting	MIL-L-6082B Straight Mineral SAE Grades	Reference Aviation Grades	MIL-L-22851 Ashless Dispersant SAE Grades
Above 60°F	50	100	20W-40 or 20W-50
30° to 90°F	40	80	20W-40
0° to 70°F	30	65	20W-40 or 20W-30
Below 10°F	20	—	20W-30

Refer to Lycoming Service Instruction 1014, latest revision, when changing from straight mineral oil to ashless dispersant oil.

8.21 FUEL SYSTEM

(a) Servicing Fuel System

At every 50 hour inspection, the fuel screens in the strainer, in the electric fuel pump and at the carburetor inlet must be cleaned.

(b) Fuel Requirements

Aviation fuel of a minimum grade of 100/130 is specified for this airplane. Since the use of lower grades can cause serious engine damage in a short period of time, the engine warranty is invalidated by the use of unapproved fuels. Refer to the latest issue of Lycoming Service Instructions 1070 for approved alternate grade fuels. See Section 1.7 Fuels.

(c) Filling Fuel Tanks

Observe all safety precautions required when handling gasoline. Fill the fuel tanks through the fillers located on the forward slope of the wings. Each wing tank holds a maximum of 16 U.S. gallons. When using less than the standard 32 gallon capacity, fuel should be distributed equally between each side. When the filler neck indicator is installed, there is approximately 10 gallons in the fuel tank when the fuel level is even with the bottom of the filler neck indicator.

(d) Draining Fuel Strainer, Sumps and Lines

The fuel system sumps and strainer bowl should be drained daily prior to the first flight and after refueling to avoid the accumulation of contaminants such as water sediment. Each fuel tank is equipped with an individual quick drain located at the lower inboard rear corner of the tank (Figure 8-3). The fuel strainer is equipped with an external quick drain located near the lower left corner of the firewall. Each of the fuel tank sumps should be drained first. Then the fuel strainer should be drained twice, once with the fuel selector valve on each tank. Each time fuel is drained, sufficient fuel should be allowed to flow to ensure removal contaminants. This fuel should be collected in a suitable container, examined for contaminants and color, and then discarded.

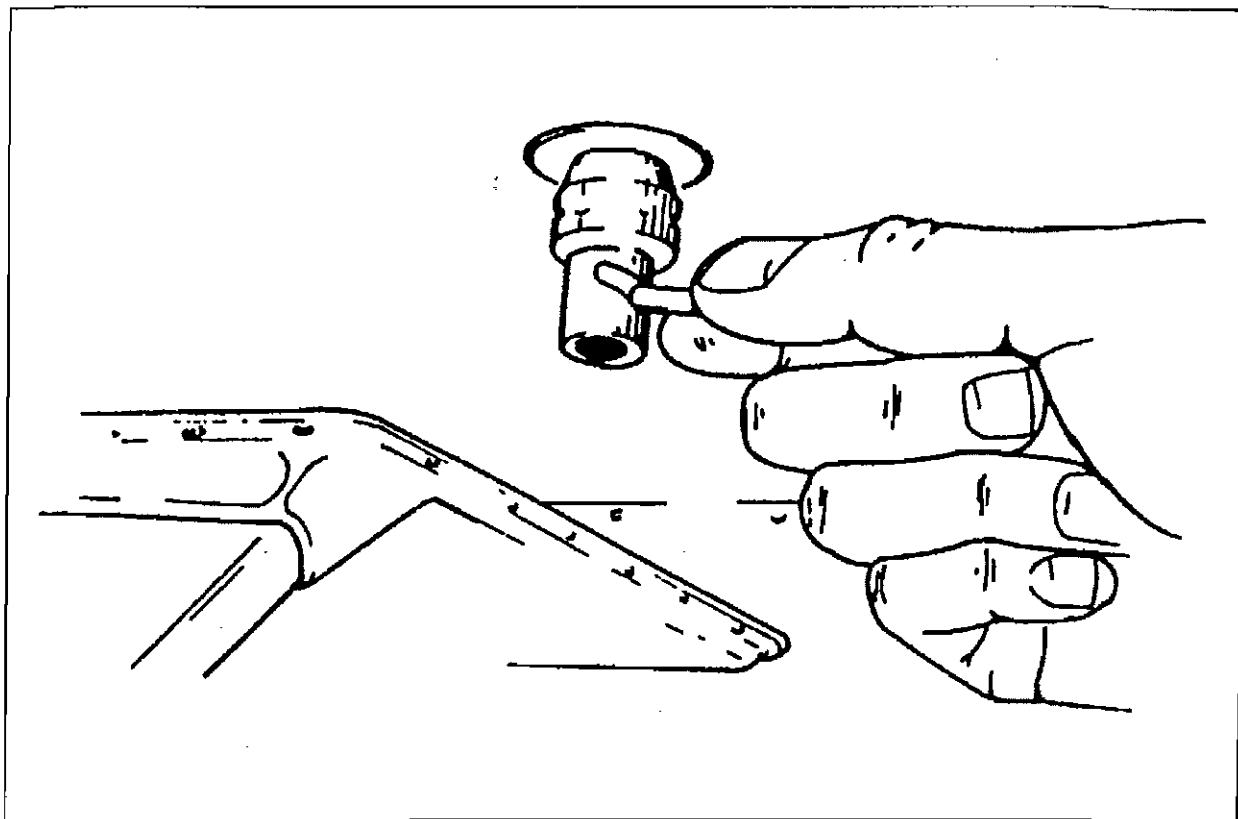

FUEL TANK DRAIN

Figure 8-3

CAUTION

When draining any amount of fuel, care should be taken to ensure that no fire hazard exists before starting the engine.

After draining, each quick drain should be checked to make sure it has closed completely and is not leaking.

(c) Draining Fuel System

The bulk of the fuel may be drained from the system by opening the valve at the inboard end of each tank. Push up on the arms of the drain valve and turn counterclockwise to hold the drain open. Drain the fuel from the fuel strainer bowl and remove the fuel supply line at the carburetor servo. Run the electric driven fuel pump until the system is completely drained, this will require selecting all fuel tanks to ensure fuel is drained from all lines.

CAUTION

When the fuel system is completely drained and fuel is replenished it will be necessary to run the engine for a minimum of 3 minutes at 1000 RPM on each tank to ensure no air exists in the fuel supply lines.

8.23 TIRE INFLATION

For maximum service from tires, keep all three inflated to the proper pressure, 26 psi for the standard 5.00 x 5 tires and 30 psi for the optional 6.00 x 6 tires*. All wheels and tires are balanced before original installation, and the relationship of tire, tube and wheel should be maintained upon reinstallation. Unbalanced wheels can cause extreme vibration in the landing gear; therefore, in the installation of new components, it may be necessary to rebalance the wheels with the tires mounted. When checking tire pressure, examine the tires for wear, cuts, bruises, and slippage.

CAUTION

Proper tire inflation must be maintained to prevent high sensitivity of the nose wheel steering during takeoff and landing.

8.25 BATTERY SERVICE

Access to the 12-volt battery is obtained by raising the right side of the top cowl and removing the cover of the battery box. The battery box has

*6.00 x 6 wheel assemblies are standard on aircraft with serial nos. 38-81A0001 and up. Optional on earlier aircraft.

a drain tube which is normally closed off with a cap and which should be opened occasionally to drain off any accumulation of liquid.

The battery should be checked for proper fluid level. DO NOT fill the battery above the baffle plates. DO NOT fill the battery with acid - use only water. A hydrometer check will determine the percent of charge in the battery.

If the battery is not up to charge, recharge starting at a 4 amp rate and finishing with a 2 amp rate. Quick charges are not recommended.

8.27 CLEANING

(a) Cleaning Engine Compartment

Before cleaning the engine compartment, place a strip of tape on the magneto vents to prevent any solvent from entering these units.

- (1) Place a large pan under the engine to catch waste.
- (2) With the engine cowling removed, spray or brush the engine with solvent or a mixture of solvent and degreaser. In order to remove especially heavy dirt and grease deposits, it may be necessary to brush areas that were sprayed.

CAUTION

Do not spray solvent into the alternator, vacuum pump, starter, or air intakes.

- (3) Allow the solvent to remain on the engine from five to ten minutes. Then rinse the engine clean with additional solvent and allow it to dry.

CAUTION

Do not operate the engine until excess solvent has evaporated or otherwise been removed.

- (4) Remove the protective tape from the magnetos.
- (5) Lubricate the controls, bearing surfaces, etc., in accordance with the Lubrication Chart in the PA-38-112 Service Manual.

(b) Cleaning Landing Gear

Before cleaning the landing gear, place a plastic cover or similar material over the wheel and brake assembly.

- (1) Place a pan under the gear to catch waste.
- (2) Spray or brush the gear area with solvent or a mixture of solvent and degreaser, as desired. Where heavy grease and dirt deposits have collected, it may be necessary to brush areas that were sprayed, in order to clean them.
- (3) Allow the solvent to remain on the gear from five to ten minutes. Then rinse the gear with additional solvent and allow to dry.
- (4) Remove the cover from the wheel and remove the catch pan.
- (5) Lubricate the gear in accordance with the Lubrication Chart in the PA-38-112 Service Manual.

(c) Cleaning Exterior Surfaces

The airplane should be washed with a mild soap and water. Harsh abrasives or alkaline soaps or detergents could make scratches on painted or plastic surfaces or could cause corrosion of metal. Cover areas where cleaning solution could cause damage. To wash the airplane, use the following procedure:

- (1) Flush away loose dirt with water.
- (2) Apply cleaning solution with a soft cloth, a sponge or a soft bristle brush.
- (3) To remove exhaust stains, allow the solution to remain on the surface longer.
- (4) To remove stubborn oil and grease, use a cloth dampened with naphtha.
- (5) Rinse all surfaces thoroughly.
- (6) Any good automotive wax may be used to preserve painted surfaces. Soft cleaning cloths or a chamois should be used to prevent scratches when cleaning or polishing. A heavier coating of wax on the leading surfaces will reduce the abrasion problems in these areas.

(d) Cleaning Windshield and Windows

- (1) Remove dirt, mud and other loose particles from exterior surfaces with clean water.
- (2) Wash with mild soap and warm water or with aircraft plastic cleaner. Use a soft cloth or sponge in a straight back and forth motion. Do not rub harshly.
- (3) Remove oil and grease with a cloth moistened with kerosene.

CAUTION

Do not use gasoline, alcohol, benzene, carbon tetrachloride, thinner, acetone, or window cleaning sprays.

- (4) After cleaning plastic surfaces, apply a thin coat of hard polishing wax. Rub lightly with a soft cloth. Do not use a circular motion.
- (5) A severe scratch or mar in plastic can be removed by rubbing out the scratch with jeweler's rouge. Smooth both sides and apply wax.

(e) Cleaning Headliner, Side Panels and Seats

- (1) Clean headliner, side panels, and seats with a stiff bristle brush, and vacuum where necessary.
- (2) Soiled upholstery, except leather, may be cleaned with a good upholstery cleaner suitable for the material. Carefully follow the manufacturer's instructions. Avoid soaking or harsh rubbing.

CAUTION

Solvent cleaners require adequate ventilation.

- (3) Leather should be cleaned with saddle soap or a mild hand soap and water.

(f) **Cleaning Carpets**

To clean carpets, first remove loose dirt with a whisk broom or vacuum. For soiled spots and stubborn stains use a nonflammable dry cleaning fluid. Floor carpets may be removed and cleaned like any household carpet.

8.29 LUBRICATION

To prolong the life of the airplane and to reduce the frequency of extensive and expensive repairs, the airplane should be periodically lubricated in accordance with the instructions presented in the PA-38-112 Service Manual.

8.31 WINTERIZATION

For winter operation a winterization plate is installed on the inlet opening of the oil cooler baffle chamber. This plate should be installed whenever the ambient temperature is 50° F or less. When not in use, the plate is attached to the right rear engine baffle.

Winterization Kit 61862: This kit should be installed at temperatures below 50°F. When this kit is installed, an OAT indicator is required. The kit must be removed when the OAT is above 50°F.

TABLE OF CONTENTS

SECTION 9

SUPPLEMENTS

Paragraph/Supplement No.	Page No.
9.1 General.....	9-1

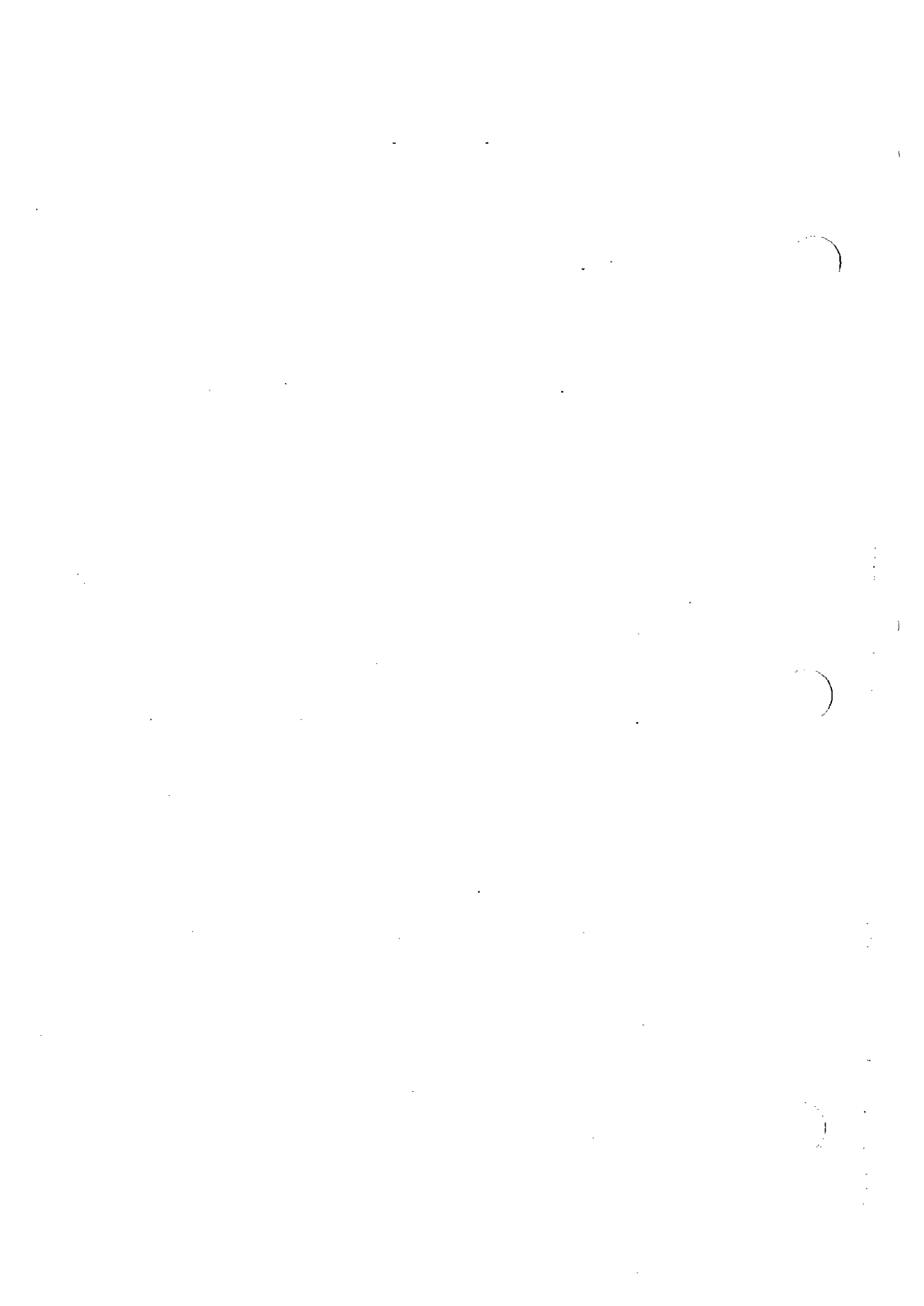

SECTION 9
SUPPLEMENTS

9.1 GENERAL

This section provides information in the form of Supplements which are necessary for efficient operation of the airplane when equipped with one or more of the various optional systems and equipment not provided with the standard airplane.

All of the Supplements provided by this section are "FAA Approved" and consecutively numbered as a permanent part of this Handbook. The information contained in each Supplement applies only when the related equipment is installed in the airplane.

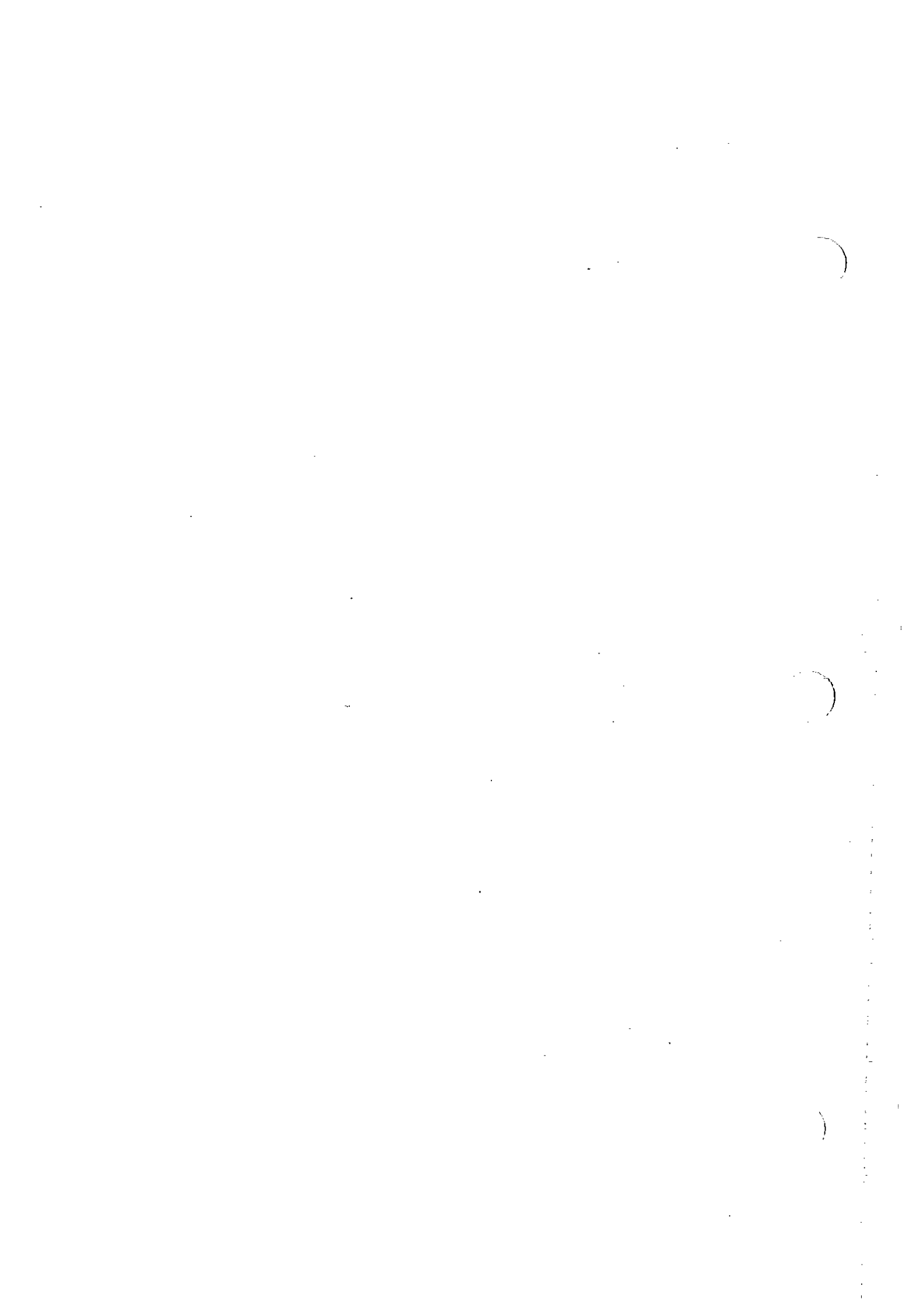
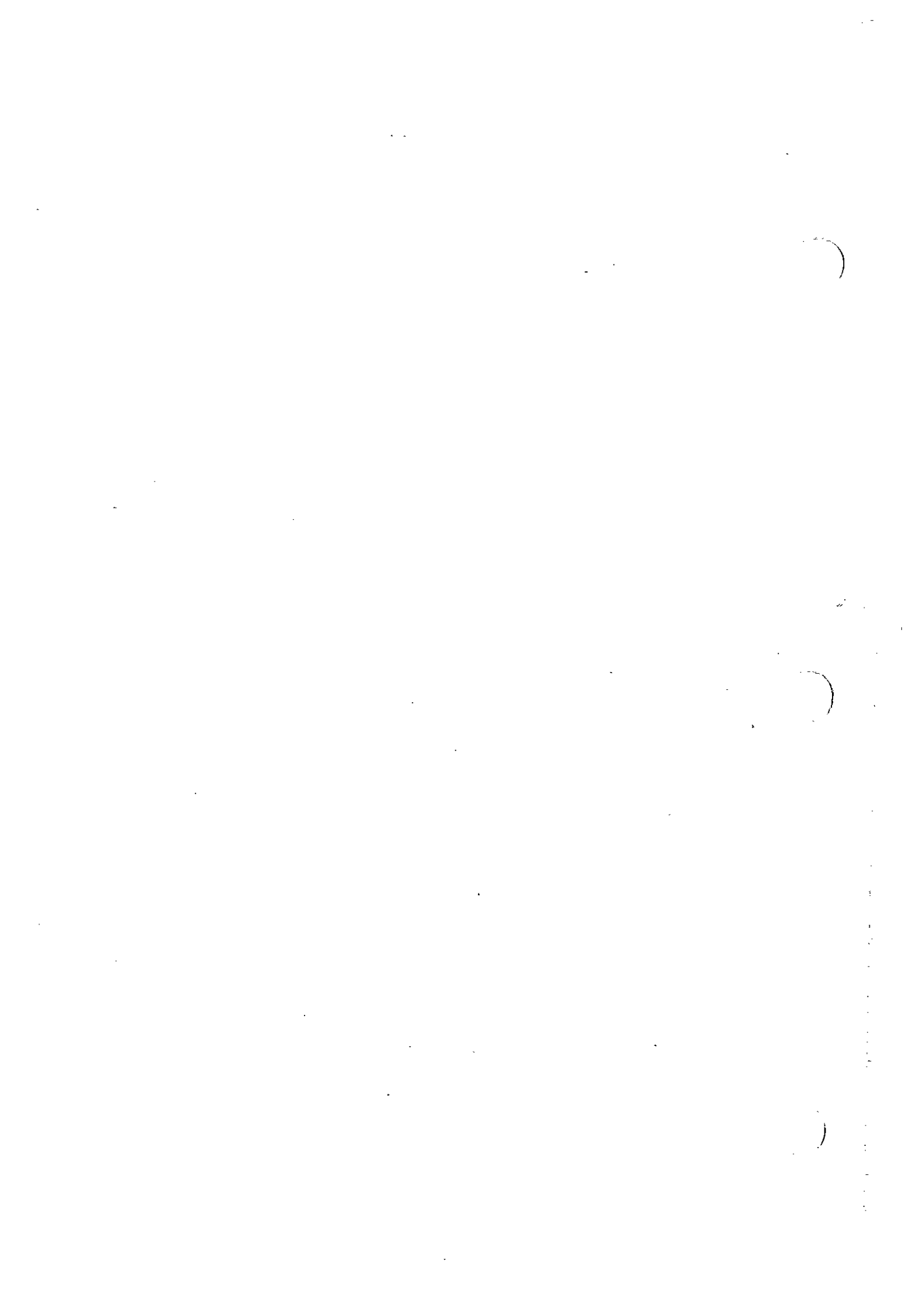

TABLE OF CONTENTS

SECTION 10

SAFETY TIPS

Paragraph No.		Page No.
10.1	General.....	10-1
10.3	Safety Tips.....	10-1



SECTION 10

SAFETY TIPS

10.1 GENERAL

This section provides safety tips of particular value in the operation of the Piper Tomahawk.

10.3 SAFETY TIPS

- (a) Learn to trim for takeoff so that only a very light back pressure on the control wheel is required to lift the airplane off the ground.
- (b) The best speed for takeoff is about 60 KIAS under normal conditions. Trying to pull the airplane off the ground at too low an airspeed decreases the controllability of the airplane in the event of engine failure.
- (c) Flaps may be lowered at airspeeds up to 89 KIAS. To reduce flap operating loads, it is desirable to have the airplane at a slower speed before extending the flaps.
- (d) Before attempting to reset any circuit breaker, allow a two to five minute cooling off period.
- (e) Before starting the engine, check that all radio switches, light switches and the pitot heat switch are in the off position so as not to create an overloaded condition when the starter is engaged.
- (f) Strobe lights should not be operating when flying through overcast and clouds, since reflected light can produce spacial disorientation. Do not operate strobe lights when taxiing in the vicinity of other aircraft.

- (g) The rudder pedals are suspended from a torque tube which extends across the fuselage. The pilot should become familiar with the proper positioning of the feet on the rudder pedals so as to avoid interference with the torque tube when moving the rudder pedals or operating the toe brakes.
- (h) In an effort to avoid accidents, pilots should obtain and study the safety related information made available in FAA publications such as regulations, advisory circulars, Aviation News, AIM and safety aids.
- (i) The shape of the wing fuel tanks is such that in certain maneuvers the fuel may move away from the tank outlet. If the outlet is uncovered, the fuel flow will be interrupted and a temporary loss of power may result. Pilots can prevent inadvertent uncovering of the outlet by avoiding maneuvers which could result in uncovering the outlet.

Extreme running turning takeoffs should be avoided as fuel flow interruption may occur.

Prolonged slips or skids which result in excess of 2000 ft. of altitude loss, or other radical or extreme maneuvers which could cause uncovering of the fuel outlet must be avoided as fuel flow interruption may occur when tank being used is not full.

- (j) The airplane should not be flown in severe turbulence as damage to the airframe structure could result.

Information contained
in this section is not
part of the
Manufacturers Pilot
Operating Handbook

This section is for use
at pilot discretion
only

SECTION 4 - PERFORMANCE

4.1 - PERFORMANCE CHARTS

The charts in this Section contain data establishing weight limitations for take-off and landing in accordance with Air Navigation Orders Section 20.7.4.

Extrapolation outside the boundaries of the performance charts is not permitted. When the outside air temperature and/or pressure height is below the lowest range scheduled on the charts, the aeroplane performance shall be assumed to be no better than that appropriate to this lowest range. The performance information is not valid when the outside air temperature and/or pressure height exceed the maximum values for which this information is scheduled.

4.2 - TAKE-OFF

The gross weight of the aeroplane for take-off shall not exceed the lesser of :

- (i) the maximum take-off weight specified in Section 2 of this Manual; and
- (ii) the gross weight for take-off determined from the take-off weight chart of this Section.

The take-off chart is based on factored take-off distances from rest to a height of 50 feet with the engine operating at take-off power. The surface corrections on the chart are based on standard factors related to strips with a firm surface. Soft ground and unusually long and/or wet grass will increase the take-off distance over that scheduled and the pilot should therefore ensure that adequate strip length is available to cover these conditions.

For sealed and gravel surfaces, the gross weight for take-off shall be determined as for a short dry grass surface.

The technique used in establishing the take-off distance is such that the aeroplane is held on or close to the ground until the appropriate take-off safety speed is approached, and the climb away then commenced so that this speed is achieved and maintained at or before the 50 foot height point.

When included on the take-off weight chart, the climb weight limitation graph provides for a weight restriction to ensure that the aeroplane achieves the required 6 percent climb gradient at take-off. This graph is based on a climb at the take-off safety speed using take-off power.

4.3 - LANDING

The gross weight of the aeroplane for landing shall not exceed the lesser of:

- (i) the maximum landing weight specified in Section 2 of this Manual; and
- (ii) the gross weight for landing determined from the landing weight chart of this Section.

The landing weight chart is based on factored landing distances on a short dry grass surface from a height of 50 feet to stop. The chart is also applicable to sealed and gravel strips. Wet and/or slippery surfaces will increase the landing distance over that scheduled and the pilot should therefore ensure that adequate strip length is available to cover these conditions.

The technique used in establishing the landing distance is such that the aeroplane approaches at the given approach speed in a glide through the 50 foot height point at the strip threshold. After touchdown, maximum wheel braking is used to bring the aeroplane to a stop.

When included on the landing weight chart, the climb weight limitation graph provides for a weight restriction to ensure that the aeroplane achieves the required 3.2 percent climb gradient during a baulked landing. This graph is based on an all engines operating climb at the approach speed using take-off power.

TAKE-OFF WEIGHT CHART

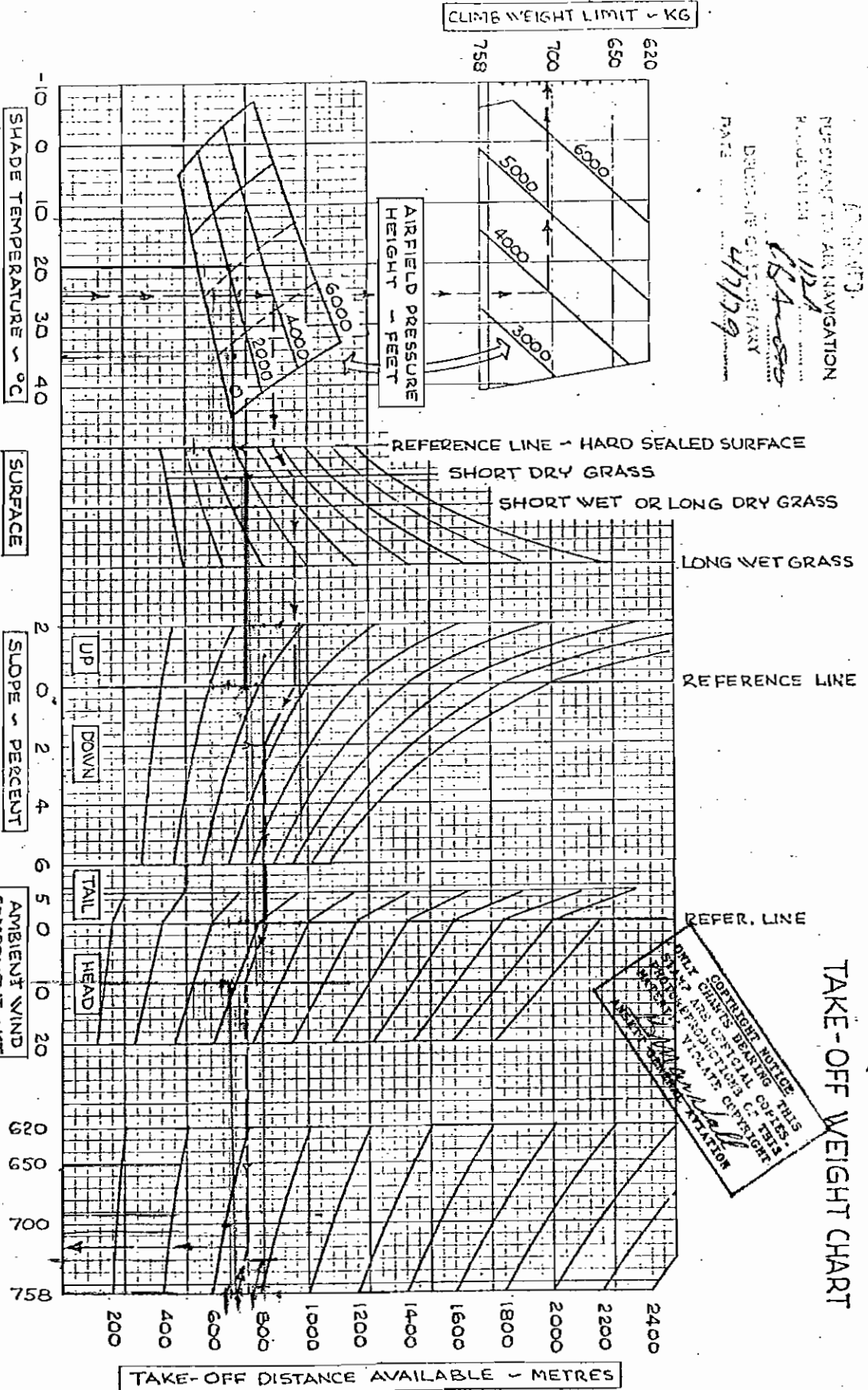

© 1979 by
B. & G. ASSOCIATES PTY. LTD.
AV-117-01/ISSUE 1/20-6-79/JB

THIS CHART IS APPLICABLE ONLY TO A PA-38-112 AFT WITH BOTH OUTBOARD AND INBOARD FLOW STRIPS INSTALLED ON V. 65

FLAP SETTING ~ ZERO
TAKE-OFF SAFETY SPEED ~ 65 KIAS
POWER SETTING ~ FULL THROTTLE
STATIC R.P.M. ~ NOT LESS THAN 2250
CHART DISTANCE FACTOR ~ 1.15

NOTE: TAKE-OFF WEIGHT MUST NOT EXCEED CLIMB WEIGHT LIMIT ABOVE.

COPYRIGHT NOTICE: THIS CHART BEARING COPIES. REPRODUCTION WITHOUT PERMISSION IS PROHIBITED. COPYRIGHT © 1979 BY B. & G. ASSOCIATES PTY. LTD.

PURSUANT TO AIR NAVIGATION
 REGULATIONS
 112/12/1979

SIGNATURE OF OPERATOR
[Signature]
 DATE 4/7/79

PIPER MODEL PA-38-112
 (SEE NOTE BELOW)
 LANDING DISTANCE CHART

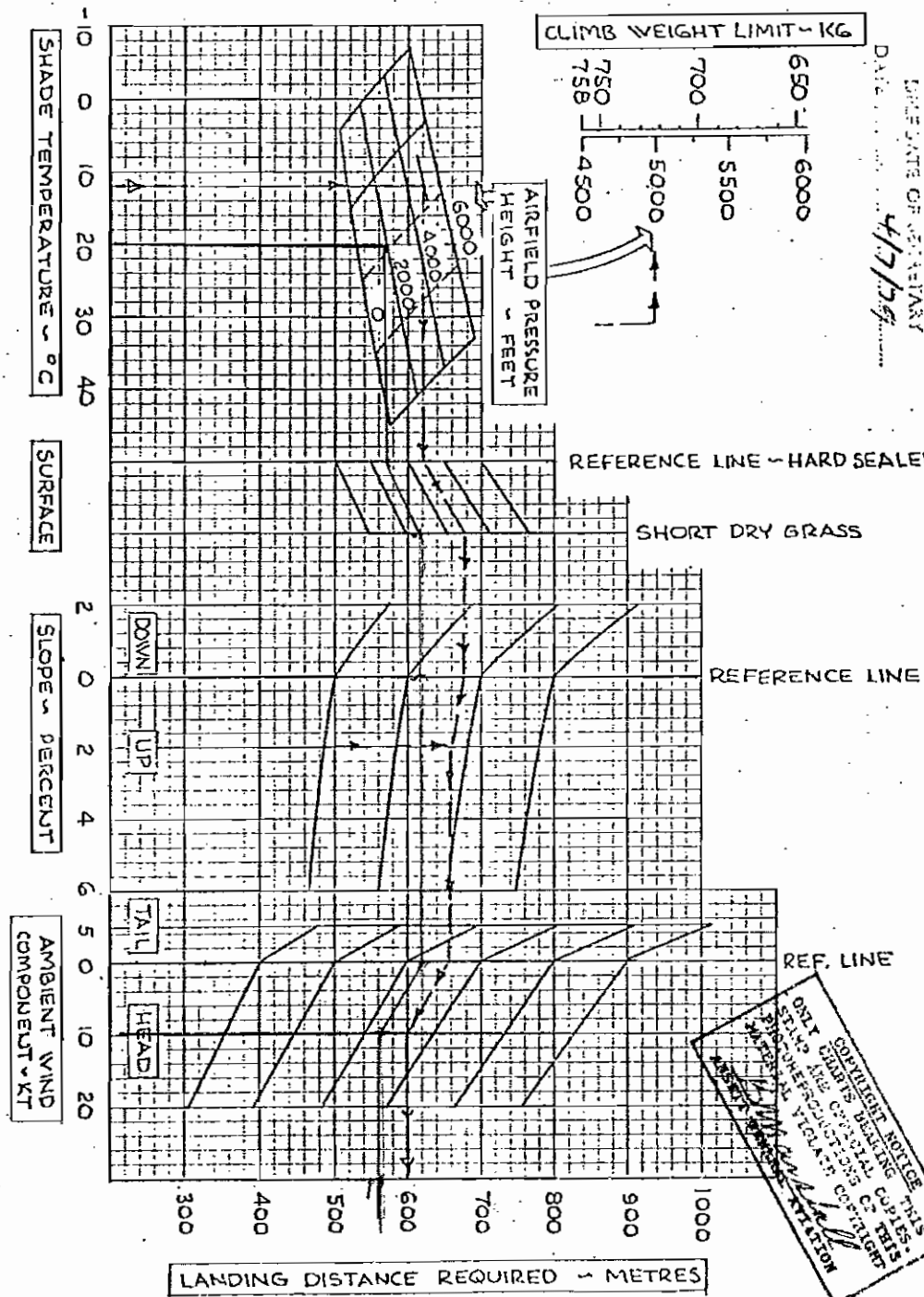

IMPORTANT NOTICE
 THIS CHART'S DESIGN, CONSTRUCTION, AND CONTENTS ARE THE PROPERTY OF PIPER AIRCRAFT CORPORATION. ALL RIGHTS RESERVED. NO PART OF THIS CHART MAY BE REPRODUCED OR TRANSMITTED IN ANY FORM OR BY ANY MEANS, ELECTRONIC OR MECHANICAL, WITHOUT THE WRITTEN PERMISSION OF PIPER AIRCRAFT CORPORATION.

© 1979 by
 B. & G. ASSOCIATES PVT. LTD.
 AV-117-02/ISSUE 1/20-6-79/JB

THIS CHART IS APPLICABLE ONLY TO AIRCRAFT WITH BOTH OUTBOARD AND INBOARD FLOW STRIPS INSTALLED ON WINGS.

FLAP SETTING ~ FULL
 APPROACH SPEED ~ 69 KIAS
 CHART DISTANCE FACTOR ~ 1.15
 NOTE:
 LANDING WEIGHT MUST NOT EXCEED CLIMB WEIGHT LIMIT ABOVE

SECTION 6 - LOADING DATA

6.1 - GENERAL

This Section contains basic weight and centre of gravity information necessary to ensure correct loading of the aeroplane and comprises Aeroplane Weight and Loading System pages. Both of these documents, separately approved by the Secretary to the Department of Transport or an aircraft weight control design signatory, are to be carried in the Flight Manual at all times.

6.2 - AEROPLANE WEIGHT

Aeroplane Type : ... PA-38-112

Registration Marking : VH- RCX

Issue	Date	Date of Expiry
ONE	14.10.80	INDEFINITE

Aeroplane Weight and Centre of Gravity Data :

Item	Weight kg	Arm mm aft of datum	Index Unit kg mm	Cabin Configuration
1* EMPTY	527	1878	989706	2 SEATS
2* BASIC	533	1868	995644	2 SEATS

NOTE : The above weight(s) include

1* UNUSABLE FUEL AND UNDRAINABLE OIL

2* UNUSABLE FUEL AND FULL OIL

J. R. REGISTER

APPROVED

in accordance with D.O.T.
Approval Stamp
Weight Control Authority
Approval No. AV 41

DATE	ISSUE	AUTHORISED
14-10-80	ONE	<i>J.R. Register</i>

6.3 - LOADING SYSTEM

Aeroplane Type : PA-38-112

Registration Marking VH- RCX

ISSUE	DATE
ONE	14.10.80

LOADING RULES

- 1. PILOT ONLY, MAXIMUM BAGGAGE = 45KG.
- 2. TWO OCCUPANTS, MAXIMUM BAGGAGE = 36KG.
- 3. TWO OCCUPANTS, CHECK ALL UP WEIGHT.

NOTE: IN UTILITY CATEGORY NIL BAGGAGE ALLOWED.

ABOVE RULES APPLY TO BASIC WEIGHT SPECIFIED IN SECTION 6.2 DATED 14.10.80.

J. R. REGISTER		
APPROVED		
in accordance with D.O.T. <small>Approval Stamp</small> Weight Control Authority Approval No. AV 41		
DATE	ISSUE	AUTHORISED
14-10-80	ONE	J. R. Register

PREPARED	IPER AIRCRAFT CORP. DEVELOPMENT CENTER, VERO BEACH, FLA.	REPORT ..2135.....
CHECKED		PAGE12.....
APPROVED		MODEL ...PA38-112...

6.2 - Aeroplane Weight

Aeroplane Type PA38-112.

Registration Marking VH- MHN

S/No. 38-79A0017

Issue	Date	Date of Expiry
ONE	18/4/79	INDEFINITE

Aeroplane Weight and Centre of Gravity Data:

Weight (Kg) (see note below)	Arm (millimeters) Aft of the Datum	Index Units kg.mm/1000	Cabin Configuration
EMPTY 523.8	1877	983.075	Two Seats
BASIC -528.9	1865	986.255	Two Seats

Note: The above weight(s) include _____

EMPTY - Unusable fuel and undrainable oil.

BASIC - Unusable fuel and full oil.

ANSETT GENERAL AVIATION



Bruce D. Clissold
 Aircraft Weight Control
 Authority Number AN-9.

Approval
 Stamp

PERMITTED	PER AIRCRAFT CORP. DEVELOPMENT CENTER, VERO BEACH, FLA.	REPORT ... 2135.....
CHANGED		PAGE 13.....
APPROVED		MODEL PA38-112.

6.3 - Loading System

Aeroplane Type PA38-112.....

Registration Marking VH-MHN S/No. 38-79A0017.....

ISSUE	DATE
ONE	18/4/79

The following is valid only for the Empty Weight specified in 6.2 - Aeroplane Weight dated 18/4/79.

1. With PILOT ONLY maximum baggage 45 kg.
2. With TWO OCCUPANTS maximum baggage 32 kg.
3. With TWO OCCUPANTS, check all up weight.

NOTE: In Utility Category Operations the Baggage Compartment must be empty.

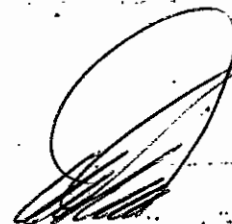

ANSEYTT GENERAL AVIATION

Bruce D. Clissold
Aircraft Weight Control
Authority Number AN-9.

PREPARED	SUPER AIRCRAFT CORP DEVELOPMENT CENTER, VERO BEACH, FLORIDA	REPORT ... 2135
CHECKED		PAGE ... 12
APPROVED		MODEL ... PA38-112

6.2 - Aeroplane Weight

Aeroplane Type PA38-112

Registration Marking VH- TOM

S/No. 38-78A0488

Issue	Date	Date of Expiry
ONE	21/12/78	INDEFINITE

Aeroplane Weight and Centre of Gravity Data:

Weight (Kg) (see note below)	Arm (millimeters) Aft of the Datum	Index Units Kg.MM/1000	Cabin Configuration
EMPTY 531.9	1879	999.620	Two Seats
BASIC 537.1	1867	1002.799	Two Seats

Note: The above weight(s) include _____

EMPTY - Unusable fuel and undrainable oil.

BASIC - Unusable fuel and full oil.

ANSETT GENERAL AVIATION



Bruce D. Clissold
Aircraft Weight Control
Authority Number AN-9.

Approval
Stamp

CORRECTED
AFTER 2/23/79

6.3 - Loading System

Aeroplane Type ... PA38-112

Registration Marking VH-TOM S/No. 38-78A0488

ISSUE	DATE
ONE	21/12/78

The following is valid only for the empty weight specified in 6.2 -
Aeroplane Weight dated 21/12/78.

1. With PILOT ONLY Maximum Baggage 45 kg.
2. With TWO OCCUPANTS Maximum Baggage 33 kg.
3. With TWO OCCUPANTS, check all up weight.

NOTE: In Utility Category Operations the
Baggage Compartment must be empty.



ANSETT GENERAL AVIATION :

Bruce D. Clissold
Aircraft Weight Control
Authority Number AN-9.

